



Germanischer Lloyd



BUREAU  
VERITAS



*ACO Marine Product Catalogue*

**ACO GM-X and GM-X-VACplus drainage pipes  
and steel fittings for the marine industry**



**GM-X Steel drain pipes and fittings DN 40 - DN 250 EN 1123**

ACO Marine, as a division of the international ACO Group of companies with more than 4200 employees worldwide, offers proven galvanized and coated steel pipe product ranges GMX for drainage systems. Specially trained contacts in the ACO Marine sales department, can provide complete support and discuss any special requirements and bespoke designs. ACO Marine's experience in this field is confirmed through certification from renowned international test registers.

The collection and disposal of wastewater is a decisive factor in shipbuilding, repair and conversion to ensure trouble-free operation. GM-X steel pipes meet the highest safety demands (see behaviour in fire).

The requirement for cost and weight saving can also be taken into account by the GM-X plug-in socket system. A significantly lower weight is possible with GM-X steel pipes than with welded pipes or threaded pipes due to the reduced wall thickness.

## CONTENT

### Table of Contents

	<b>page</b>
Introduction	<b>2</b>
Material properties	<b>2</b>
GM-X Socket/Seal/tightness	<b>4</b>
Vacuum installations/seal	<b>5</b>
Deck and bulkhead penetrations	<b>5</b>
Corrosion proofing/Installation instructions	<b>6</b>
Production monitoring/test information/QM	<b>8</b>
Delivery programme-overview	<b>9</b>

### Dimensions and weights

GM-X Socket dimensions	<b>10</b>
How to generate Order number	<b>11</b>
GM-X Pipes	<b>12</b>
GM-X Bends	<b>13</b>
GM-X Angle bends	<b>14</b>
GM-X Tank connectors/Forked T-pieces	<b>15</b>
GM-X Offsets/Bends with smoothing section	<b>16</b>
GM-X Branches	<b>17</b>
GM-X Connecting pieces	<b>20</b>
GM-X Cleaning pipes	<b>21</b>
GM-X Pipe bridges/Drain traps	<b>22</b>
WC connections	<b>23</b>
GM-X Connectors and bends with threads	<b>24</b>
GM-X Transition pipes	<b>25</b>
GM-X Connectors	<b>26</b>
GM-X Deck and bulkhead penetration form T1, R1A, R1B	<b>27</b>
GM-X Deck and bulkhead penetration form J3, J4	<b>27</b>
GM-X Deck and bulkhead penetration form E, F, R2B, R2A, T2, T3, P1, P2, P3	<b>28</b>
GM-X Socket flange and spigot flange	<b>30</b>
GM-X Deck and bulkhead penetrations to go through main vertical fire zone boundaries form T1S, R1S, J3, P1S, P2S, T2S	<b>31</b>
Seals	<b>32</b>
Pipe clips	<b>33</b>
Drain plugs	<b>34</b>
Accessories	<b>35</b>

## Material

Drain pipes and fittings are manufactured from welded, one-time cold-drawn precision steel pipe in accordance with DIN 2394.

### Tensile strength:

Rm 310-410 N/mm<sup>2</sup>

### Elongation at break:

A5 min. 28%

As a material, steel is practically properties:

- **unbreakable**
- **dimensionally stable**
- **heat and frost proof**
- **favourable acoustic behaviour**
- **non-combustible**

## Thermal expansion

With steel, thermal expansion is exceptionally limited. When a 1 metre piece of pipe is heated by 100°C, the length increase is 1.1 mm. The thermal expansion produced by the introduction of hot wastewater does not therefore need to be considered in the installation. This does not apply to other standard expansion materials.

### Expansion of various pipe materials

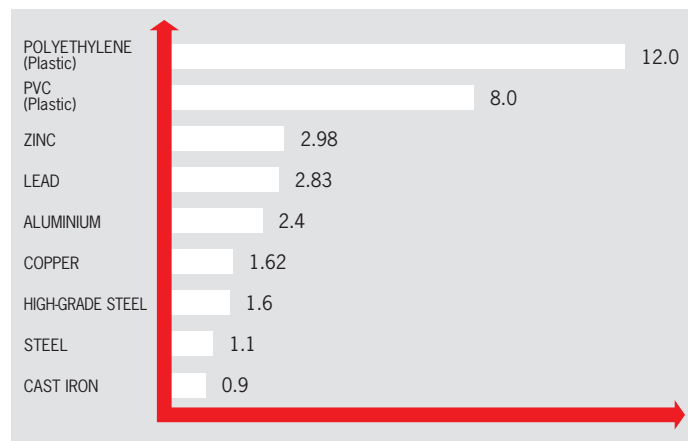

Increase in length of a body 1 m long when heated by 100°C.

## Acoustic behaviour & Behaviour in fire

Sound measurements of discharge noises in built-in drain pipes produced results within the requirements of DIN 4109.

The measured noise figure was below the permissible sound level.

To further decrease discharge noise, and as an additional sound-proofing measure, plastic insulating supports can be inserted in the socket bed on which the pipe ends sit.

The steel drain pipe is fireproof. As per DIN 4102 and DIN 1123, steel drain pipe is classified as Incendiary Matter A1 - non flammable.

**The GM-X Socket**

The GM-X socket is a two-stage design. The seal is retained by the first socket stage. The second stage centres the inserted pipe. The socket shape construction enables a solid, buckle-proof and rigid connection of pipes and mouldings to be made, and thus

guarantees great tightness between the pipe and the socket, without the risk of the seal being compressed by its own or an outside load.



**GM-X Seal**

The GM-X seal is in the shape of a lip collar. It is inserted into the upper socket chamber. As a result of the other pipe end being pushed in, the sealing lips are forced against the inner wall of the seal housing and against the outer wall of the inserted pipe. The seal collar is located on the socket rim and ensures the seating of the seal when the other pipe is pushed in. The sealing lips press more firmly against the pipe walls as fluid pressure rises, thus positively increasing the tightness of the joint.

The seal is manufactured as standard from an effluent-resistant grade (as per DIN 4060):

- NBR (Nitrile Butadiene Rubber)**
- SBR (Styrene Butadiene Rubber)**

For special use areas seals can be supplied in the following grades on request:

- EPDM (APTK)**
- CR (Neoprene)**
- Si (Silicon)**
- FKM (Viton)**



**Seal-tight values**

The socket seal-tight connection value requirements in DIN EN 1123 are met. All pipes and fittings, including their joints, are tight at an inside and outside pressure above atmospheric of 0 to 0.5 bar.

For lines in which high pressures can occur, the GM-X securing clip is to be used for extra security against axial thrust.

Instead of the securing clip, GM-X securing clamps are supplied for DN 150 and DN 200 pipes and fittings for axial stability.

The following seal-tight values were determined for GM-X seal joints with securing clips and glued-on seals:

Operation pressure		
DN	40	15 bar
DN	50	15 bar
DN	70	5 bar
DN	80	5 bar
DN	100	5 bar
DN	125	4 bar
DN	150	2 bar
DN	200	1 bar

## The vacuum connection

The vacuum installation with x-socket and GM-X-VACplus sealing element, corresponds to installations of the standard GM-X sealing element.

In contrast to the aforementioned installation the GM-X-VACplus sealing element fills both socket stages.

Therefore guaranteeing a trouble-free vacuum operation. The seal-tight value of the vacuum seal joint complies with DIN 86 281.



## GM-X-VACplus seal

The GM-X-VACplus sealing element allows the vacuum installations with „standard socket Type A1“. The GM-X-VACplus seal is in the shape of a lip collar. As result of the

other pipe end being pushed in, the sealing lips are forced against the inner wall of the seal housing and against the outer wall of the inserted pipe.



## Deck and bulkhead penetration with flange

Parts of the flange are not hot galvanized, therefore welding procedures in decks and bulkheads are possible.

**In accordance to:**

DIN 86280  
DIN EN ISO 15749  
DIN 86287  
DIN 86288  
DIN EN 1123



## Deck and bulkhead penetration with thick-walled pipe

The welded body is not hot galvanized, so that it can be welded in decks and bulkheads.

**In accordance to:**

DIN 86280  
DIN EN ISO 15749  
DIN 86287  
DIN 86288  
DIN EN 1123



All pipes and fittings are hot galvanized inside and out. The zinc coating is on average 400 g/m<sup>2</sup> or 56 µ. It is impact-resistant and shock-proof. The zinc coating produces a cathodic protection of the cut edges thus preventing bottom rust. In addition, the insides of the pipes and fittings are given an alkyd-melamine resin based plastic coating.

Due to this internal coating of the pipes, frictional resistance on the internal surfaces is reduced and incrustation largely prevented. Together with the zinc coating, optimum corrosion protection is achieved.

Both the hot galvanizing and the additional internal coating meet the requirements of DIN EN 1123.

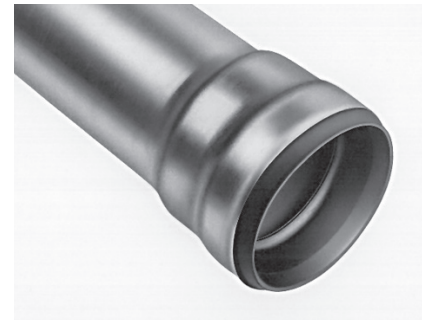
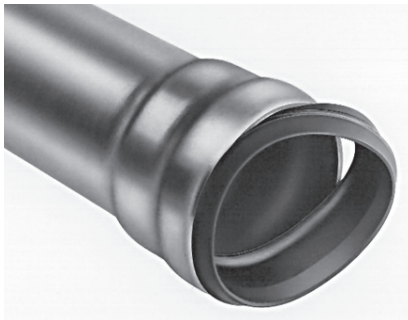

## Installation

A significant task falls upon the installer, who, in the final analysis, determines the practical value of a drainage installation. The superior quality of our pipe material and the first-class processing of our products help him in this task.

Drainage installations have to be able to be constructed without problems and work without any malfunction. Any connection problem can be quickly and economically resolved by the availability of an extensive range of fittings.

The extensively developed socket joint enables rapid and simple plug-in assembly, just by turning the pipe and the fitting in the socket.

Steel pipes and fittings are easy to handle, impact-resistant and shock-proof, and unaffected by rough treatment during installation.

The GM-X Drain pipe range can also be supplied with two sockets. When a pipe is cut to size, there is a piece left over with a socket, which can be used as an extra fitting piece.

Steel drain pipes and fittings - together with the characteristic plug-in socket joint - give the installed drain pipe a practically self-supporting stability. The use of pipe clips and holding devices is only necessary at critical locations in the installation.

## Cutting length

Cutting to length can be done with a pipe cutter, a cutting wheel or a saw.

Pipes cut to length with a wheel or saw must be de-burred before being inserted in the socket so as not to damage the seal.

- 1. The seal is placed obliquely on the lower edge of the socket chamber.**
- 2. Using your forefinger to press the seal to one side, push it into the socket chamber.**
- 3. On releasing, the seal should pop into the socket chamber. (Adjust where necessary)**

Note:

The outside seal edge collar must rest on the socket rim.

- 4. The seal is coated all-over inside with GM-X lubricant**

- 5. The pipe end is inserted into the socket by turning gently until it is located on the lower socket end.**

Note:

In time the lubricant dries out in time. The socket joint can be loosened again by heating the socket area.

A correct fit of the inserted pipe end into the socket is especially important for the installation of vacuum and positive pressure piping systems.

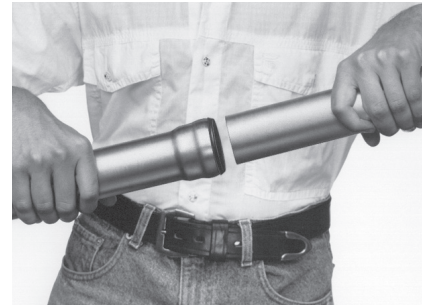

## Undoing the socket joint

The insertion pipe is heated around the socket with a heat source until the pipe can be pulled out of the socket. When re-assembling, the seal must be changed.

## Pipe fixing

For horizontally mounted pipes, the dead weight of the pipe plus the possible water content and the number of fixing points are to be taken into account when choosing fixing materials.

The following ACO Marine fixing devices can be supplied:

- **Securing clips for axial thrust and**

## Connecting to other types of pipes

The GM-X range has a selection of connectors for joining GM-X pipes to other types of pipes.

- for suspending the pipes (perforated belt or steel hoop)**
- **Pipe clips with knock-in pin or rod for welding without sound-proofing insert**
- **Pipe clips for threaded pin with or without sound-proofing insert**

### Weights of 1 m pipe filled with water

DN	40	2,9 kg
DN	50	4,0 kg
DN	70	7,0 kg
DN	80	9,4 kg
DN	100	12,8 kg
DN	125	22,0 kg
DN	150	29,0 kg
DN	200	58,0 kg
DN	250	77,4 kg

## **Production monitoring**

GM-X drain pipes and fittings are subject to production monitoring by monitoring by a certified institute.

GM-X seals are also subject to production monitoring by a certified institute.

## **Quality management**

GM-X drain pipes and fittings are subject to production in accordance to DIN EN ISO 9001:2000.













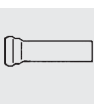

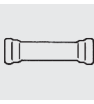



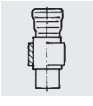





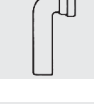
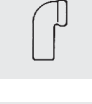

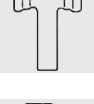



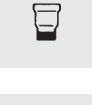

## **Certification**

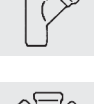
GM-X pipes and special fittings are certified by all leading test registers. This affirms their high operational safety.

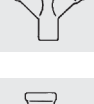



Delivery range overview GM-X sockets DN 40 to DN 250

GM-X page 11		<b>Pipes with 1 socket</b>	GM-X page 20		<b>Double sockets</b>	GM-X page 27		<b>WC connections in acc. to DIN 86288</b>
GM-X page 12		<b>Pipes with 2 sockets</b>	GM-X page 20		<b>Push-in sockets with long socket</b>	GM-X page 29		<b>Socket flange Spigot flange</b>
GM-X page 13		<b>Bends</b>	GM-X page 21		<b>Cleaning pipes</b>	GM-X page 31		<b>Deck and bulk-head penetrations to go through main vertical fire zone</b>
GM-X page 14		<b>Angle bends with normal or short socket</b>	GM-X page 22		<b>Pipe bridges</b>			
GM-X page 14		<b>Reduced angle bend with normal or short socket</b>	GM-X page 22		<b>Drain traps</b>	GM-X page 32		<b>Seal</b>
GM-X page 15		<b>Tank fittings</b>	GM-X page 23		<b>Wall closet bends 90° for vertical mounting</b>	GM-X page 33		<b>Pipe clips</b>
GM-X page 15		<b>Forked T-pieces</b>	GM-X page 23		<b>WC connections straight</b>	GM-X page 34		<b>Drain plugs</b>
GM-X page 16		<b>Offsets</b>	GM-X page 23		<b>Connections threaded</b>	GM-X page 34		<b>Protective socket caps</b>
GM-X page 16		<b>Bends with calming section</b>	GM-X page 24		<b>Angle bends threaded</b>	GM-X page 34		<b>Lubricant</b>
GM-X page 17		<b>Single branches Red. single branches</b>	GM-X page 25		<b>Concentric transition pipes</b>	GM-X page 35		<b>Securing clips Securing clamps</b>
GM-X page 18		<b>Double branches Red. double branches</b>	GM-X page 25		<b>Transition pipes eccentric</b>			
GM-X page 19		<b>Double branches for corners Red. double branches for corners</b>	GM-X page 26		<b>Connectors for changing from GM-X Sleeves to other pipe types</b>			
GM-X page 19		<b>Transition branches</b>	GM-X page 27		<b>Deck and bulk-head penetrations</b>			

**Socket dimensions**

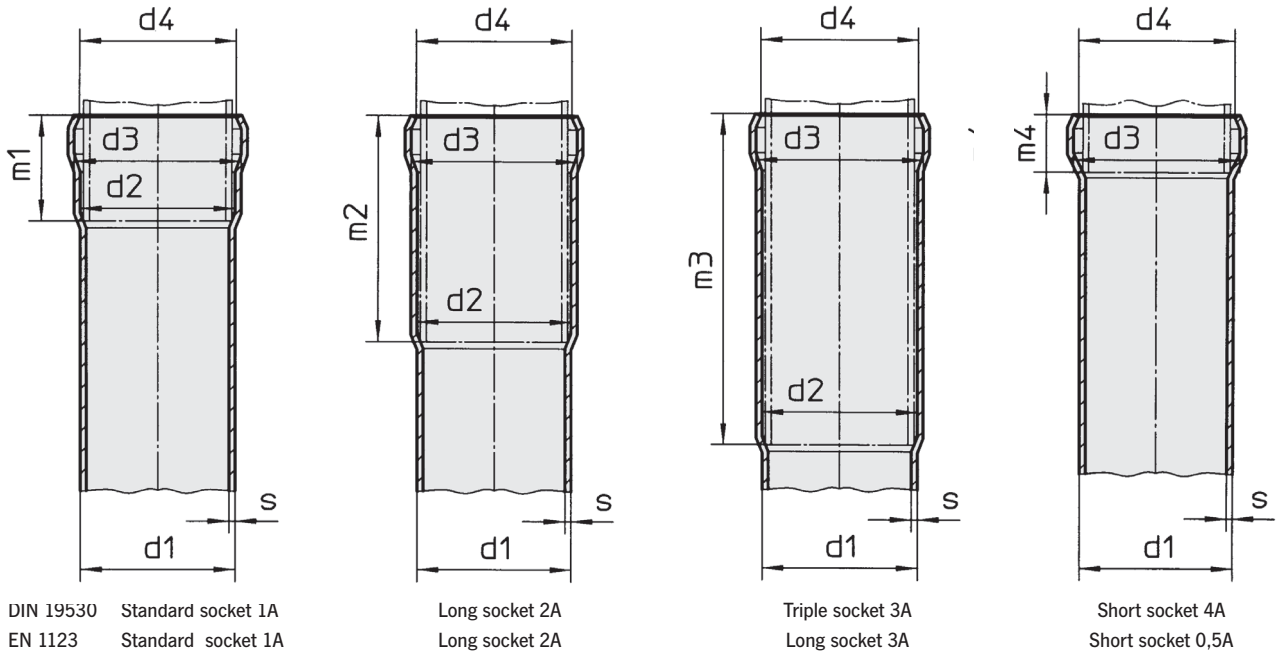

**For pipes and fittings with 2 sockets both sockets are the same design**

DN	d <sub>1</sub>	d <sub>2</sub>	d <sub>3</sub>	d <sub>4</sub>	s	m <sub>1</sub>	m <sub>2</sub>	m <sub>3</sub>	m <sub>4</sub>
040	42	45	48	45	1,5	30	70	100	16
050	53	56	60	56	1,5	38	90	130	19
070	73	76	81	76	1,6	55	120	175	27
080	89	92	99	92	1,8	60	130	190	32
100	102	106	114	107	2,0	70	150	220	38
125	133	138	147	140	2,5	75	160	235	41
150	159	164	176	168	2,5	80	170	250	56
200	219	224	241	228	2,9	120	250	370	76
250	273	280	298	284	4,0	130	270	400	90

**Special nominal widths for GM-X WC connections and prefabrication**

DN	d <sub>1</sub>	d <sub>2</sub>	d <sub>3</sub>	d <sub>4</sub>	s	m <sub>1</sub>	m <sub>2</sub>	m <sub>3</sub>	m <sub>4</sub>
110	102	114	120	115	2,0	70	150	220	32

**GM-X Plug-in connection**

Socket DN 40-200 with seal

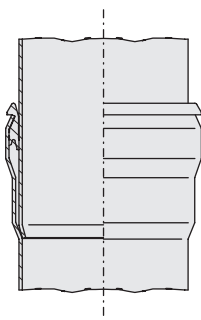

Socket DN 250 with set of seal

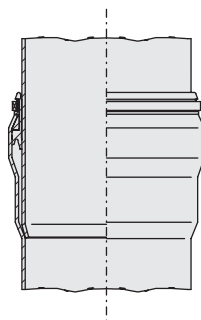

**GM-X -VACplus Plug-in connection**

Socket DN 40-70 with seal

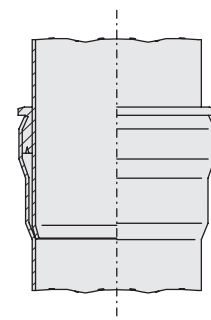

**How to generate Order number**

Order No.	X	E01 025	E01 050	E01 075	E01 100	E01 150	E01 200	E01 250	E01 275	E01 300
		Weight in kg/piece								
040	40	0,45	0,85	1,25	1,64	2,44	3,26	4,03	-	4,82
050	50	0,59	1,10	1,60	2,11	3,12	4,13	5,14	-	6,15
070	70	0,93	1,67	2,41	3,16	4,65	6,14	7,62	8,42	9,11
080	80	1,29	2,31	3,32	4,34	6,37	8,40	10,44	-	12,47
100	100	1,69	2,98	4,27	5,56	8,14	10,71	13,29	14,66	15,87
125	125	2,79	4,88	6,96	9,05	13,22	17,38	21,55	-	25,72
150	150	3,40	5,90	8,40	10,90	15,90	20,90	25,90	-	30,90
200	200	5,90	9,88	13,87	17,85	25,82	33,79	41,76	-	49,73
250	250	10,31	17,10	23,88	30,67	44,24	57,80	71,37	-	84,94

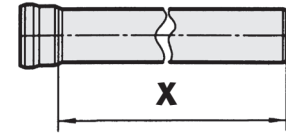

For example: If your selection is X = 1000 (E01 100), DN = 125 (125), then Order number is **E01 100 125**

**Pipes**

**GM-X drain pipes with one socket 1 A in acc. to EN 1123 form B1**

Order No.		E01 025	E01 050	E01 075	E01 100	E01 150	E01 200	E01 250	E01 275	E01 300
	I <sub>2</sub>	250	500	750	1000	1500	2000	2500	2750	3000
	DN	Weight in kg/piece								
040	40	0,45	0,85	1,25	1,64	2,44	3,26	4,03	-	4,82
050	50	0,59	1,10	1,60	2,11	3,12	4,13	5,14	-	6,15
070	70	0,93	1,67	2,41	3,16	4,65	6,14	7,62	8,42	9,11
080	80	1,29	2,31	3,32	4,34	6,37	8,40	10,44	-	12,47
100	100	1,69	2,98	4,27	5,56	8,14	10,71	13,29	14,66	15,87
125	125	2,79	4,88	6,96	9,05	13,22	17,38	21,55	-	25,72
150	150	3,40	5,90	8,40	10,90	15,90	20,90	25,90	-	30,90
200	200	5,90	9,88	13,87	17,85	25,82	33,79	41,76	-	49,73
250	250	10,31	17,10	23,88	30,67	44,24	57,80	71,37	-	84,94

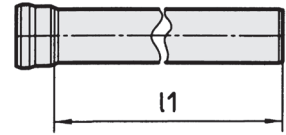

**GM-X drain pipes with two sockets 1 A in acc. to EN 1123 form B2**

Order No.		E00 025	E00 050	E00 075	E00 100	E00 150	E00 200	E00 300
	I <sub>2</sub>	250	500	750	1000	1500	2000	3000
	DN	Weight in kg/piece						
040	40	0,41	0,81	1,21	1,60	2,40	3,19	4,78
050	50	0,53	1,03	1,54	2,04	3,05	4,06	6,08
070	70	0,78	1,52	2,27	3,01	4,50	5,99	8,97
100	100	1,3	2,66	3,95	5,24	7,82	10,40	15,55
125	125	2,25	4,34	6,42	8,50	12,67	16,84	25,18
150	150	2,70	5,20	7,70	10,20	15,20	20,20	30,20
200	200	4,30	8,29	12,27	16,26	24,23	32,20	48,14

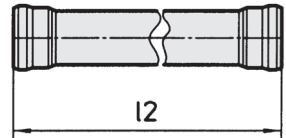

Vacuum installation in DN 40, DN 50, DN 70 with special GM-X-VACplus sealing element and standard x-socket piping system

**Bends**

**Bends in acc. to EN 1123 form C1**

Order No.	DN	R	E10 015			E10 030			E10 045			E10 070			E10 087		
			a = 15			a = 30			a = 45			a = 70			a = 87		
			a	b	kg	a	b	kg	a	b	kg	a	b	kg	a	b	kg
040	40	67,5	37	67	0,23	46	76	0,25	56	86	0,28	75	105	0,31	92	122	0,38
050	50	82,5	53	81	0,35	64	92	0,40	76	104	0,45	100	128	0,46	120	148	0,53
070	*70	117,5	50	89	0,60	66	105	0,68	83	122	0,77	118	157	0,89	146	185	1,05
080	*80	114,5	25	85	0,65	56	116	0,70	72	132	1,00	72	132	1,00	134	194	1,40
100	100		see bends with small radius														
125	125																
150	150																
200	200	305	45	165	5,35	45	165	5,35	166	270	13,26	254	360	17,30	330	434	20,18
250	250	381	-	-	-	45	164	6,44	209	399	27,80	318	448	39,50	413	543	48,30

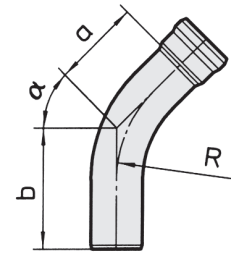

**Bends with small radius in acc. to EN 1123 form C2**

Order No.	DN	R	E12 045			E12 070			E12 087		
			a = 45			a = 70			a = 85		
			a	b	kg	a	b	kg	a	b	kg
*040	40	27	19	46	0,19	26	72	0,20	33	79	0,29
*050	50	35,5	24	79	0,32	34	89,5	0,35	43	98	0,36
*070	70	50	32	91	0,54	46	105	0,61	59	117,5	0,65
*080	80	82,5	59	119	1,60	83	143	1,40	103	163	1,72

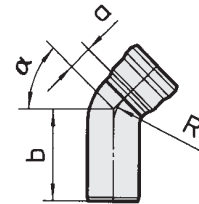

**Bends with small radius in acc. to EN 1123 form C2**

Order No.	DN	R	E10 015			E10 030			E10 045			E10 070			E10 087		
			a = 15			a = 30			a = 45			a = 70			a = 87		
			a	b	kg	a	b	kg	a	b	kg	a	b	kg	a	b	kg
*100	100	70	34	104	1,17	44	114	1,27	52	124	1,30	74	144	1,48	91	161	1,62
*125	125	90	35	110	1,90	49	124	2,09	62	137	2,15	88	163	2,40	110	185	2,60
*150	150	150	45	125	2,61	65	145	3,61	87	167	4,38	130	210	5,45	165	245	3,95

**\*Attention**

Please note, that all shaped components with bends due to production-engineering reasons. Design data is available upon request.

Vacuum installation in DN 40, DN 50, DN 70 with special GM-X-VACplus sealing element and standard x-socket piping system

**Angle bends**

**Angle bends in acc. to EN 1123 form E1**

Order No.	E30 010				
	DN	a	b	R	kg
*040	40	35	80	28	0,22
*050	50	45	100	35,5	0,35
*070	70	60	120	50	0,75
*080	80	90	152,5	82,5	1,12
*100	100	95	165	70	1,63

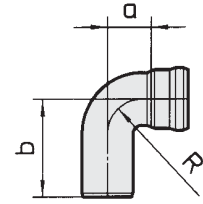

**Angle bends with short socket 4A in acc. to EN 1123 form E1**

Order No.	E30 011					
	DN	a	b	m <sub>4</sub>	R	kg
*040	40	35	80	16	28	0,22
*050	50	45	100	19	35,5	0,32

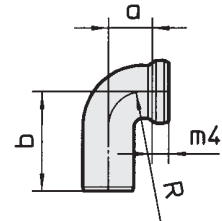

**Reduced angle bends in acc. to EN 1123 form E2**

Order No.	E30 012							
	DN1	DN2	a	b	f	d <sub>1</sub>	R	kg
*040	50	40	35	100	56	53	28	0,30
*050	70	50	45	140	70	73	35,5	0,55

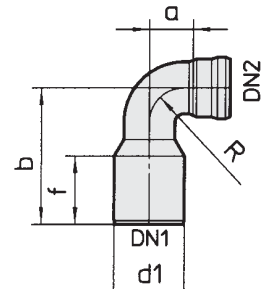

**Reduced angle bends with short socket 4A in acc. to EN 1123 form E3**

Order No.	E30 013								
	DN1	DN2	a	b	f	m <sub>4</sub>	d <sub>1</sub>	R	kg
*050	50	40	35	100	56	16	53	28	0,26

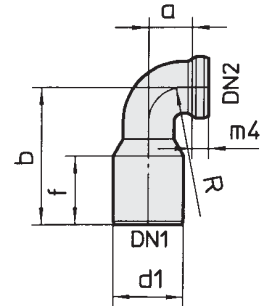

**\*Attention**

Please note, that all shaped components with the bend share varies due to production-engineering reasons. Design data is available upon request.

Vacuum installation in DN 40, DN 50, DN 70 with special GM-X-VACplus sealing element and standard x-socket piping system

**Tank fitting, forked T-pieces**

**Tank fittings in acc. to EN 1123 form E5**

Order No.	DN	* E90		
		a	R	kg
044 040	40	35	28	0,89
055 050	50	45	35,5	1,17

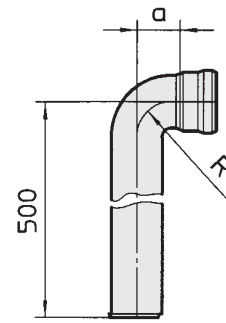

**Forked T-pieces in acc. to EN 1123 form E4**

Order No.	DN 1	DN 2	DN 3	E91			
				a <sub>1</sub>	a <sub>2</sub>	l <sub>1</sub>	kg
444 040	40	40	40	40	40	140	0,98
544 040	50	50	50	40	40	140	1,18
555 050	50	50	50	42	42	160	1,30

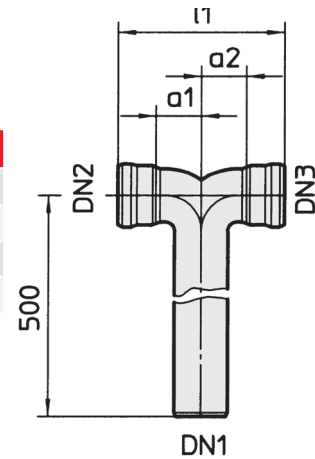

**\*Attention**

Please note, that all shaped components with the bend share varies due to production-engineering reasons.  
 Design data is available upon request.

**Offsets, bends with calming section**

**Swan-neck (2 standard range bends)**

Assembled dimensions when using 2 bends with the same angle »a«

DN	R	a = 15		a = 30		a = 45		a = 70		a = 87	
		e	l <sub>1</sub> kg	e	l <sub>1</sub> kg	e	l <sub>1</sub> kg	e	l <sub>1</sub> kg	e	l <sub>1</sub> kg
40	67,5	27	204 0,46	61	228 0,50	100	242 0,56	169	242 0,62	214	225 0,72
50	82,5	35	263 0,70	78	291 0,80	127	307 0,90	241	306 0,92	268	282 1,06
*70	117,5	36	273 1,20	86	319 1,36	145	350 1,54	258	369 1,78	331	336 2,10
*80	114,5	28	216 1,30	86	321 1,40	145	350 2,00	254	362 2,40	328	345 2,40
<b>DN 100-150 are bends with small radius</b>											
100	117,5	36	271 2,08	79	295 2,54	126	302 1,60	205	293 2,46	252	265 3,24
125	117,5	38	285 3,80	85	315 4,10	135	326 4,30	228	326 4,80	287	304 5,20
150	117,5	44	334 5,22	105	392 7,22	180	434 8,76	319	456 10,90	413	436 12,76
200	305	54	413 12,88	105	392 12,88	308	744 26,92	577	8247 35,18	464	805 45,70
250	381	-	- -	-	- -	387	935 55,60	720	1028 79,00	957	1006 96,60

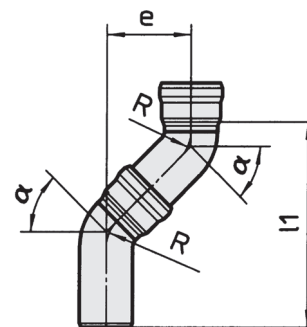

Note: see articles of bends with small radius on page 13.

**Offsets in acc. to EN 1123 form C4**

Order No.	DN	R	E20 075	E20 130	E20 200
			e = 75	e = 130	e = 200
			e l <sub>1</sub> kg	e l <sub>1</sub> kg	e l <sub>1</sub> kg
*070	70	117,5	300 73,5 1,15	335 73,5 1,30	359 73,5 1,53
*080	80	114,5	280 85 1,40	335 85 1,75	405 85 2,80
*100	100	70	250 95 1,85	300 95 2,25	370 95 2,75
*125	125	90	270 100 2,90	325 100 3,60	395 100 4,45

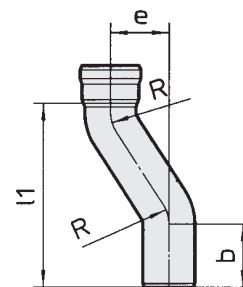

**Bends with calming section for transition into horizontal pipes in acc. to EN 1123 form C3**

Order No.	DN 1	E11 088						
		a	R	a <sub>1</sub>	a <sub>2</sub>	b <sub>1</sub>	b <sub>2</sub>	kg
*080	80	44	114,5	324	72,5	370	131	1,22
*100	100	44	70	275	53	335	123,5	2,39
*125	125	44	90	292	60	355	134	4,75

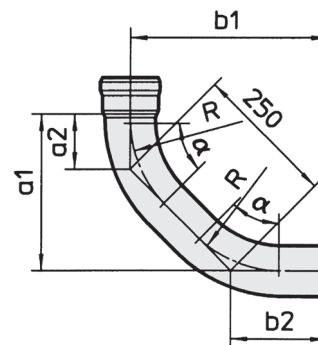

**\*Attention**

Please note, that all shaped components with the bend share varies due to production-engineering reasons. Design data is available upon request.

Vacuum installation in DN 40, DN 50, DN 70 with special GM-X-VACplus sealing element and standard x-socket piping system



**Branches**

**Single branches in acc. to EN 1123 form D1**

Order No.	DN	E50 045				E50 070				E50 087			
		a = 45				a = 70				a = 87			
		l <sub>1</sub>	b	c	kg	l <sub>1</sub>	b	c	kg	l <sub>1</sub>	b	c	kg
044	40	125	55	70	0,37	110	60	50	0,34	110	70	40	0,32
055	50	150	65	90	0,56	130	70	60	0,50	130	80	50	0,47
077	70	200	85	115	1,03	175	95	75	1,00	175	110	65	0,97
088	80	235	97	138	1,78	200	110	90	1,30	200	126	75	1,40
100	100	265	110	155	2,50	230	125	110	2,30	230	140	90	2,20
125	125	340	130	210	5,20	285	150	145	4,01	285	170	120	3,79
150	150	380	140	240	6,65	320	160	160	5,68	320	190	135	5,48
200	200	500	190	320	15,31	420	220	210	12,82	420	260	170	12,26
250	250	620	230	370	23,80	-	-	-	-	500	310	190	18,50

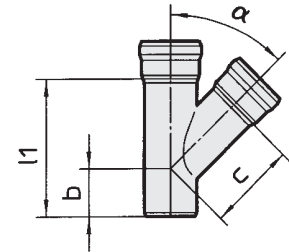

**Red. single branches in acc. to EN 1123 form D11**

Order No.	DN 1	DN 2	E51 045				E51 070				E51 087			
			a = 45				a = 70				a = 87			
			l <sub>1</sub>	b	c	kg	l <sub>1</sub>	b	c	kg	l <sub>1</sub>	b	c	kg
054	50	40	130	50	79	0,47	120	65	57	0,43	120	75	46	0,42
074	70	40	150	60	95	0,75	140	80	69	0,70	140	95	57	0,70
075	70	50	150	50	106	0,74	150	85	72	0,77	150	100	61	0,75
085	80	50	185,5	72	117	1,35	165	94	80	1,20	165	109	69,5	1,10
140	100	40	180	65	116	1,45	175	100	84	1,41	175	115	72	1,40
150	100	50	200	75	127	1,65	180	95	87	1,50	180	115	76	1,40
170	100	70	230	90	136	1,95	200	110	90	1,69	200	125	80	1,67
180	100	80	265	110	147	2,00	220	120	97	1,90	220	135	81	1,80
125	125	50	225	75	148	2,66	200	105	103	2,60	200	125	91	2,56
127	125	70	255	90	157	3,25	225	120	106	2,90	225	140	95	2,85
225	125	100	290	105	176	4,00	255	135	126	3,57	255	155	105	3,48
220	150	70	340	120	230	5,10	225	115	121	3,40	225	140	109	3,35
250	150	100	325	100	240	8,43	255	130	141	4,10	255	155	119	4,00
275	150	125	380	130	274	10,23	290	150	160	5,10	290	175	135	4,91
300	200	100	420	150	284	10,98	295	160	174	7,78	295	195	150	7,66
325	200	125	370	110	279	12,10	325	175	193	8,90	325	210	165	8,96
350	200	150	420	140	313	13,75	355	190	193	9,770	355	225	167	9,57
360	250	100	370	110	279	12,10	-	-	-	-	330	220	178	10,80
375	250	125	420	140	313	13,75	-	-	-	-	-	-	-	-
400	250	150	450	150	323	14,80	-	-	-	-	-	-	-	-
450	250	200	540	190	359	23,90	-	-	-	-	-	-	-	-

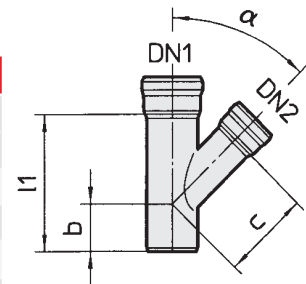

Vacuum installation in DN 40, DN 50, DN 70 with special GM-X-VACplus sealing element and standard x-socket piping system

**Branches**

**Double branches in acc. to EN 1123 form D11**

Order No.	DN	E52 045				E52 070				E52 087			
		a = 45				a = 70				a = 87			
		l <sub>1</sub>	b	c	kg	l <sub>1</sub>	b	c	kg	l <sub>1</sub>	b	c	kg
555	50	150	65	90	0,75	130	70	60	0,50	130	80	50	0,59
777	70	200	85	115	1,44	175	95	75	1,47	175	110	65	1,19
111	100	265	110	155	3,18	230	125	110	2,79	230	140	90	2,66
125	125	340	130	210	6,28	285	150	145	5,35	285	170	120	5,99
150	150	380	140	240	7,67	320	160	160	6,32	320	190	135	8,95
600	200	500	190	320	20,16	420	220	210	17,45	420	260	170	15,36

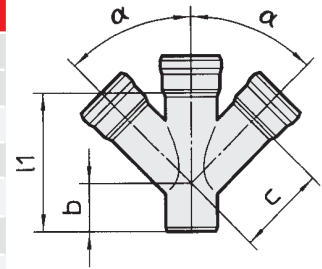

**Red. double branches in acc. to EN 1123 form D21**

Order No.	DN 1	DN 2	E52 045				E52 070				E52 087			
			a = 45				a = 70*				a = 87			
			l <sub>1</sub>	b	c	kg	l <sub>1</sub>	b	c	kg	l <sub>1</sub>	b	c	kg
755	70	50	175	75	106	1,18	150	85	72	1,00	150	100	61	1,00
177	100	70	230	90	136	2,47	200	110	90	2,00	200	125	80	1,90
188	100	80	265	110	147	2,94	220	120	97	2,65	220	135	81	2,39
325	125	100	290	105	176	4,38	255	135	126	3,85	255	155	105	3,67
350	150	100	290	95	195	5,12	255	130	141	4,52	255	155	119	4,34
400	150	125	340	120	230	5,87	290	150	160	5,91	290	175	134	5,65
800	200	100	325	100	240	8,82	295	160	174	8,08	295	195	150	7,91
850	200	125	380	13	274	10,87	325	175	193	9,79	325	210	165	9,43
900	200	150	420	150	284	12,92	355	190	193	10,81	355	225	166	10,42

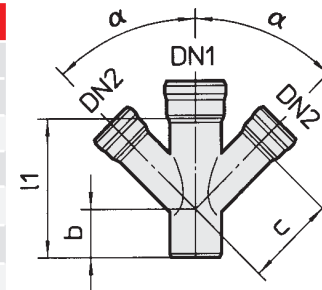

\*Parts available only on request

Vacuum installation in DN 40, DN 50, DN 70 with special GM-X-VACplus sealing element and standard x-socket piping system

**Double branches for corners in acc. to EN 1123 form D21**

Order No.	DN	E53 045				E53 070				E53 087			
		a = 45				a = 70*				a = 87			
		$l_1$	b	c	kg	$l_1$	b	c	kg	$l_1$	b	c	kg
555	50	150	65	90	0,75	130	70	60	0,60	130	80	50	0,60
777	70	200	85	115	1,44	175	95	75	1,50	175	110	65	1,19
111	100	265	110	155	3,18	230	125	110	2,80	230	140	90	2,66

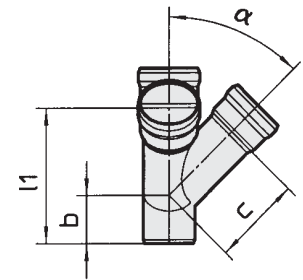

\*Parts available only on request

**Red. double branches for corners in acc. to EN 1123 form D31**

Order No.	DN 1	DN 2	E53 045				E53 070				E53 087			
			a = 45				a = 70*				a = 87			
			$l_1$	b	c	kg	$l_1$	b	c	kg	$l_1$	b	c	kg
755	70	50	175	75	106	1,20	150	85	72	1,00	150	100	61	1,00
177	100	70	230	90	136	1,95	200	110	90	2,00	200	125	80	1,90
325	125	100	290	105	176	4,40	255	135	126	3,85	255	155	105	3,70
350	150	100	290	95	196	5,10	255	130	141	4,50	255	155	119	4,30

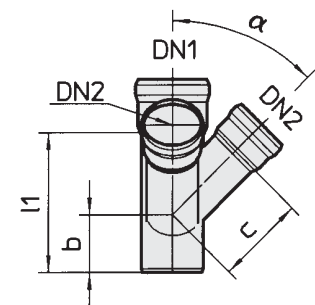

\*Parts available only on request

**Transition branches in acc. to EN 1123 form D12**

Order No.	DN 1	DN 2	DN 3	E54 045				E54 070				E54 087			
				a = 45				a = 70*				a = 87			
				$l_1$	b	c	kg	$l_1$	b	c	kg	$l_1$	b	c	kg
544	50	40	40	150	50	79	0,48	140	65	57	0,43	140	75	46	0,42
545	50	40	50	170	65	90	0,60	150	70	60	0,50	150	80	50	0,50
744	70	40	40	200	60	95	0,86	185	80	69	0,86	185	95	57	0,80
745	70	40	50	210	75	106	0,85	195	85	72	0,90	195	100	61	0,70
754	70	50	40	200	60	95	0,80	180	80	69	0,70	180	95	57	0,70
755	70	50	50	200	75	106	0,85	180	85	72	0,70	180	100	61	0,75

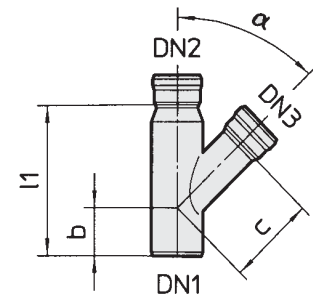

\*Parts available only on request

Vacuum installation in DN 40, DN 50, DN 70 with special GM-X-VACplus sealing element and standard x-socket piping system

**Connecting pieces**

**Double sockets in acc. to EN 1123 Form F4**

Order No.	DN	E70 020		
		I <sub>1</sub>	I <sub>2</sub>	kg
040	40	16	76	0,14
050	50	18	94	0,22
070	70	25	135	0,45
080	80	25	145	0,60
100	100	40	180	0,97
125	125	40	190	1,61
150	150	40	200	2,12
200	200	50	290	5,70
250	250	60	320	7,10

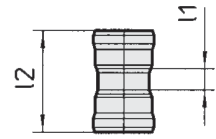

**Push-in sockets with long socket in acc. to EN 1123 form F5**

Order No.	DN	E70 040		
		I <sub>1</sub>	I <sub>2</sub>	kg
040	40	50	70	0,20
050	50	60	90	0,32
070	70	70	120	0,58
080	80	80	130	0,80
100	100	90	150	1,21
125	125	100	160	2,17
150	150	115	170	2,86
200	200	150	250	6,85

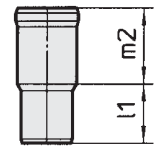

**Repair coupling**

Order No.	DN	E70 030	
		I <sub>1</sub>	kg
040	40	53	0,10
050	50	70	0,16
070	70	103	0,34
100	100	130	0,55
125	125	139	1,2

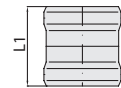

Vacuum installation in DN 40, DN 50, DN 70 with special GM-X-VACplus sealing element and standard x-socket piping system

**Cleaning pieces**

**Cleaning pipes with round cleaning aperture  
in acc.to EN 1123 form H1**

Order No.	E70 010							
	DN	$l_1$	n	$d_{12}$	$d_{13}$	x	y	kg
040	40	125	80	36	M6	78	15	0,47
050	50	150	95	45	M6	86	15	0,60
070	70	200	125	60	M6	100	15	0,92
080	80	210	135	76	M8	124	23	1,00
100	100	265	165	96	M8	164	23	2,18
125	125	290	180	125	M8	191	27	3,20
150	150	320	190	125	M8	191	27	4,30
200	200	420	260	125	M8	191	27	10,50

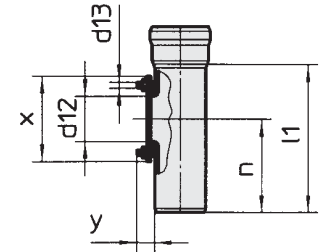

**Cleaning pipes with oblong cleaning aperture  
in acc. to EN 1123 form H3**

Order No.	E70 015			
	DN	$l_1$	n	kg
100	100	450	255	5,30
125	125	455	260	7,20
150	150	460	265	7,90
200	200	500	285	14,00
250	250	580	340	21,30

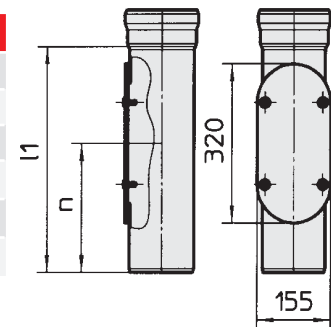

Clear width of cleaning aperture = 265 x 100 mm.

Vacuum installation in DN 40, DN 50, DN 70 with special GM-X-VACplus sealing element and standard x-socket piping system

**Pipe bridges, drain traps**

**Pipe bridges\* in acc. to EN 1123 form G3**

Order No.	DN	E20 410					kg
		b	l <sub>1</sub>	w	d <sub>13</sub>	e	
*050	50	70	430	60	115	110	1,11
*070	70	73,5	576	100	170	170	3,64
*100	100	95	690	100	190	198	4,70

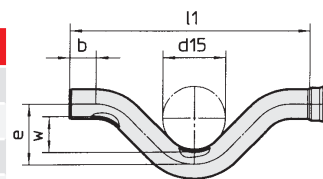

\*Available with threaded plug drain on request.

**P-drain traps\* in acc. to EN 1123 form G1**

Order No.	DN	E20 441				kg
		n <sub>2</sub>	k <sub>1</sub>	R	n <sub>3</sub>	
*070	70	172	190	50	220	1,80
*080	80	247	215	82,5	330	3,64
*100	100	234	240	70	303	3,75

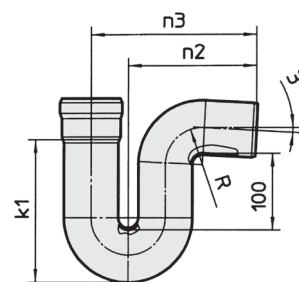

\*Available with threaded plug drain on request.

**S-drain traps\* in acc. to EN 1123 form G2**

Order No.	DN	E20 420				kg
		n <sub>2</sub>	k <sub>1</sub>	k <sub>2</sub>	R	
*070	70	150	190	154	50	1,9
*100	100	200	240	216	70	4,2

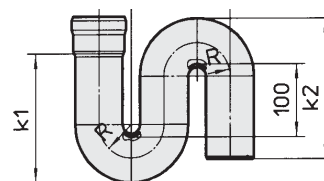

\*Available with threaded plug drain on request.

**\*Attention**

Please note, that all shaped components with bends may vary due to production-engineering reasons. Design data is available upon request.

Vacuum installation in DN 40, DN 50, DN 70 with special GM-X-VACplus sealing element and standard x-socket piping system

**WC-connections**

with short socket to fit plastic pipe DN 80 (Ø 90 mm), with special socket to fit plastic socket pipe DN 100 (Ø 110 mm)

Wall closet bend 90 for vertical mounting, with inserted seal  
 in acc. to EN 1123 form E6

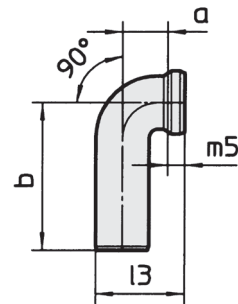

Order No.	530 195					
	DN	a	b	m <sub>s</sub>	R	kg
*080	80	55	130	31	130,5	0,95
*100	100	57	161	34	143	1,54

WC-connections, straight with inserted seal  
 in acc. to EN 1123 form E9

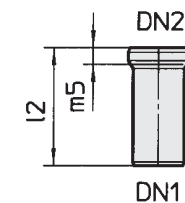

Order No.	530 170				
	DN 1	DN 2	l <sub>2</sub>	m <sub>s</sub>	kg
100	100	110	165	32	0,95

**Special WC-connections**

WC Connector with seal

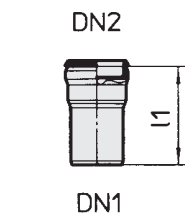

Order No.	E95 014			
	DN 1	DN 2	l <sub>1</sub>	kg
100	80	110	250	1,3

**\*Attention**

Please note, that all shaped components with bends may vary due to production-engineering reasons. Design data is available upon request.

**Deck and bulkhead penetration**

GM-X Euro-WC deck penetration with sealing element form J3 in accordance to DIN 86288

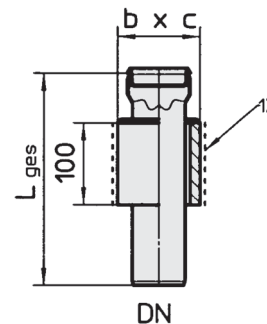

Order No.	E 97						
	DN	Form	L [mm]	c [mm]	b [mm]	cut-out [mm]	weight [kg]
145 001	100	J3	275	8,8	144,0	154	5,10

GM-VAC WC connector deck penetration in accordance to DIN 86288

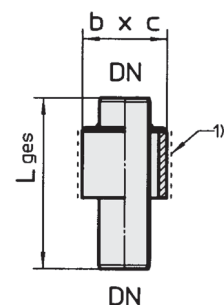

Order No.	V 97						
	DN	Form	L [mm]	c [mm]	b [mm]	cut-out [mm]	weight [kg]
091 001	40	J4	180	8,8	76,1	78	1,4
092 001	50	J4	180	8,8	88,9	90	1,7

Vacuum installation in DN 40, DN 50, DN 70 with special GM-X-VACplus sealing element and standard x-socket piping system

**Connectors and bends with threads**

**Connectors with external thread\*  
in acc. to DIN 86287/86288 form L3**

Order No.	560			
	DN	G	I <sub>1</sub>	kg
011 040	40	R 1 1/4"	120	0,22
010 040	40	R 1 1/2"	120	0,25
011 050	50	R 1 1/4"	120	0,30
012 050	50	R 1 1/2"	120	0,35
010 050	50	R 2"	120	0,40

**Connectors with internal thread\*  
in acc. to DIN 86287/86288 form L1**

Order No.	560			
	DN	G	I <sub>1</sub>	kg
111 040	40	R 1 1/4"	120	0,22
110 040	40	R 1 1/2"	120	0,25
111 050	50	R 1 1/4"	120	0,30
112 050	50	R 1 1/2"	120	0,35
110 050	50	R 2"	120	0,40

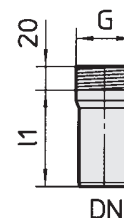

\*Not for use with sanitary installations (DIN 1986).

**Connectors with external thread\*  
in acc. to DIN 86287/86288 form L5**

Order No.	E60				
	DN	G	I <sub>1</sub>	I <sub>2</sub>	kg
204 040	40	R 1 1/4"	45	90	0,20
210 040	40	R 1 1/2"	45	90	0,34
205 040	40	R 2"	55	100	0,35
204 050	50	R 1 1/4"	58	115	0,25
205 050	50	R 1 1/2"	48	105	0,30
210 050	50	R 2"	35	105	0,45
210 070	70	R 2 1/2"	50	120	0,60

**Connectors with internal thread\*  
in acc. to DIN 86288 form L5**

Order No.	E60				
	DN	G	I <sub>1</sub>	I <sub>2</sub>	kg
214 040	40	R 1 1/4"	45	90	0,20
211 040	40	R 1 1/2"	47	92	0,25
212 040	40	R 2"	60	105	0,35
215 050	50	R 1 1/4"	48	105	0,32
214 050	50	R 1 1/2"	43	100	0,30
211 050	50	R 2"	48	105	0,40

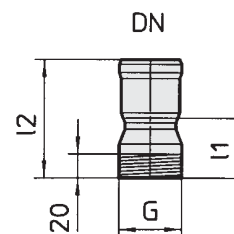

\*Not for use with sanitary installations (DIN 1986).

**Angle bend with external thread\*  
in acc. to DIN 86287/86288 form L4**

Order No.	* 530				
	DN	G	a	b	kg
140 040	40	R 1 1/2"	63	80	0,28
140 050	50	R 2"	70	100	0,33

**Angle bend with internal thread\*  
in acc. to DIN 86287/86288 form L2**

Order No.	* 530				
	DN	G	a	b	kg
120 040	40	R 1 1/4"	67	80	0,30
100 040	40	R 1 1/2"	67	80	0,40
120 050	50	R 1 1/4"	74	100	0,35
110 050	50	R 1 1/2"	74	100	0,40
100 050	50	R 2"	74	100	0,50

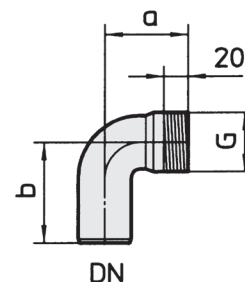

\*Not for use with sanitary installations (DIN 1986).

**\*Attention**

Please note, that all shaped components with bends may vary due to production-engineering reasons. Design data is available upon request.

Vacuum installation in DN 40, DN 50, DN 70 with special GM-X-VACplus sealing element and standard x-socket piping system



**Transition pipes**

**Transition pipes, concentric in acc. to EN 1123 form F2**

Order No.			E40		
	DN 1	DN 2	$l_1$	f	kg
100 054	40	50	85	60	0,21
100 074	40	70	120	87	0,45
110 075	50	70	110	65	0,40
100 150	50	100	160	104,5	0,83
110 087	70	80	110	87	0,65
120 170	70	100	140	109	0,95
130 132	70	125	160	96	1,35
120 180	80	100	140	100	0,95
140 225	100	125	160	100	1,65
150 250	100	150	170	110	1,95
155 300	100	200	250	140	2,05
150 275	125	150	150	107	2,20
155 325	125	200	255	158	4,40
155 350	150	200	235	158	4,50
156 450	200	250	280	220	8,20

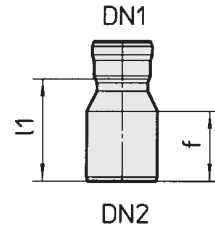

**Transition pipes, concentric with extended spigot end, fits securing clips in acc. to EN 1123 form F3**

Order No.			E41		
	DN 1	DN 2	$l_1$	f	kg
100 054	40	50	100	75	0,35
110 075	50	70	130	105	0,50
110 087	70	80	135	105	1,00
120 170	70	100	155	115	1,05
120 180	80	100	155	120	1,05
140 225	100	125	190	130	2,35
150 275	125	150	170	132	2,50
155 350	150	200	255	170	4,25

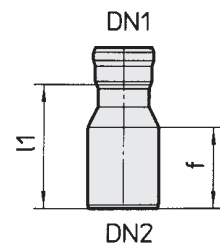

**Transition pipes, eccentric in acc. to EN 1123 form F1**

Order No.			E40		
	DN 1	DN 2	$l_1$	f	kg
160 054	40	50	110	60	0,27
160 074	40	70	115	70	0,42
160 075	50	70	140	80	0,40
160 150	50	100	157	100	0,89
160 087	70	80	135	84	0,70
160 170	70	100	160	104	1,08
160 132	70	125	167	100	1,25
160 180	80	100	165	100	1,60
160 225	100	125	182	100	1,87
160 250	100	150	194	103	2,55
160 275	125	150	210	105	2,66
160 350	150	200	272	150	4,92

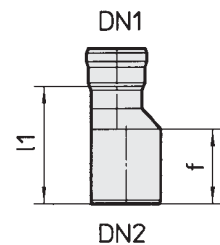

Vacuum installation in DN 40, DN 50, DN 70 with special GM-X-VACplus sealing element and standard x-socket piping system

**Connectors**

**Connectors for changing from GM-X pipe to plastic pipe socket as per in acc. to EN 1123 form E16**

- DIN 19531 (PVC, hart)**
- DIN 19534 (PVC, hart)**
- DIN 19535 (PE, hart) ≥ DN 70**
- DIN 19537 (HDPE)**
- DIN 19560 (PP)**
- DIN 19561 (ABS/ASA)**

Order No.	DN 1	DN 2	E40				
			$l_1$	f	$d_{10}$	s	kg
300 040	40	50	60	45	50	1,5	0,16
300 050	50	50	60	45	50	1,5	0,20
310 050	50	70	100	60	75	1,5	0,36
310 070	70	70	95	60	75	1,6	0,47
311 070	70	100	120	80	110	2,0	1,10
313 080	80	80	-	-	-	-	-
311 080	80	100	115	80	110	2,0	0,89
311 100	100	100	110	80	110	2,0	0,93
312 100	100	125	140	85	125	2,0	1,20
312 125	125	125	130	85	125	2,5	1,80
315 100	100	150	160	100	160	2,5	1,98
315 125	125	150	150	100	160	2,5	2,17
	150	150	<b>fits without connectors</b>				
316 150	150	200	180	110	200	2,0	2,73
316 200	200	200	150	110	200	2,0	4,15

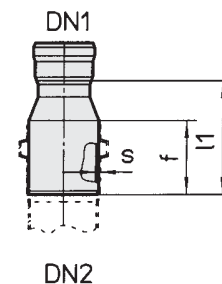

$d_{10}$  plastic pipe diameter

**Connectors for changing from GM-X pipe to plastic pipe socket as per in acc. to EN 1123 form E17**

Order No.	DN 1	DN 2	E40				
			$l_1$	f	$d_{10}$	s	kg
610 040	40	50	90	50	56	1,5	0,23
610 050	50	50	62	50	56	1,5	0,22

$d_{10}$  plastic pipe diameter

Vacuum installation in DN 40, DN 50, DN 70 with special GM-X-VACplus sealing element and standard x-socket piping system

**Deck and bulkhead penetrations**

**GM-X Deck and bulkhead penetrations form T1 in accordance to DIN 86288**

Order No.	E 97						
	DN	Form	L [mm]	c [mm]	b [mm]	cut-out [mm]	weight [kg]
011 001	40	T1	260	8,8	88,9	90	2,1
012 001	50	T1	270	8,8	88,9	90	2,2
013 001	70	T1	290	8,8	108,0	109	3,4
014 001	80	T1	290	8,8	133,0	134	4,4
015 001	100	T1	310	8,8	152,4	154	5,3
016 001	125	T1	335	8,8	193,7	195	6,3
017 001	150	T1	360	8,8	219,1	221	7,7
018 001	200	T1	450	8,8	273,0	274	14,5
019 001	250	T1	500	8,8	355,6	357	21,8

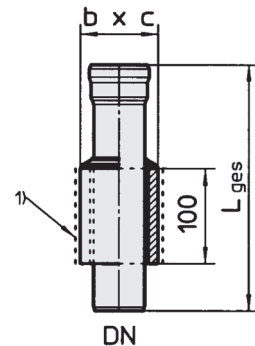

**GM-X Deck and bulkhead penetrations form R1A and R1B in accordance to DIN 86288**

Order No.	E 97								
	DN	Form	L [mm]	c [mm]	b [mm]	excess length f [mm]	cut-out [mm]	weight [kg]	
021 001	40	R1B	140	8,8	70,0	0	71	1,7	
031 001	40	R1A	148	8,8	70,0	8	71	1,62	
022 001	50	R1B	150	8,8	82,5	0	84	2,0	
032 001	50	R1A	160	8,8	82,5	10	84	2,0	
023 001	70	R1B	170	10,0	108,0	0	109	3,0	
033 001	70	R1A	183	10,0	108,0	13	109	3,0	
024 001	80	R1B	180	10,0	127,0	0	128	4,1	
034 001	80	R1A	196	10,0	127,0	16	128	3,8	
025 001	100	R1B	200	10,0	139,7	0	141	4,4	
035 001	100	R1A	219	10,0	139,7	19	141	4,9	
026 001	125	R1B	200	11,0	177,8	0	179	4,7	
036 001	125	R1A	222	11,0	177,8	22	179	6,6	
027 001	150	R1B	200	8,0	219,1	0	221	5,8	
037 001	150	R1A	228	8,0	219,1	28	221	6,6	
028 001	200	R1B	270	11,0	273,0	0	274	11,6	
038 001	200	R1A	300	11,0	273,0	30	274	8,9	
029 001	250	R1B	300	8,0	323,9	*	*	13,17	
039 001	250	R1A	300	8,0	323,9	*	*	13,17	

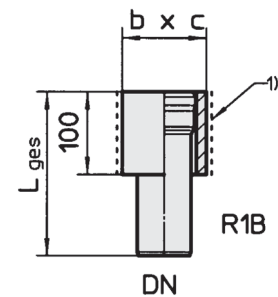
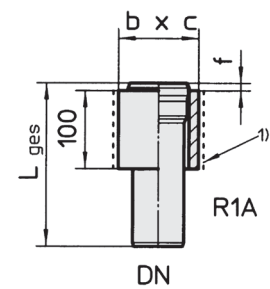

Vacuum installation in DN 40, DN 50, DN 70 with special GM-X-VACplus sealing element and standard x-socket piping system

**Deck and bulkhead penetrations**

**GM-X weld-on pieces with socket form E**

Order No.	E 97						
	DN	Form	L [mm]	c [mm]	b [mm]	cut-out [mm]	weight [kg]
071 001	40	E	210	8,8	63,5	65	1,4
072 001	50	E	210	8,8	76,1	77	1,6
073 001	70	E	210	8,8	95,0	96	2,2
074 001	80	E	210	8,8	127,0	128	3,2
075 001	100	E	210	8,8	133,0	134	3,3
076 001	125	E	230	8,8	168,3	170	4,67
077 001	150	E	230	8,8	193,7	195	5,5
078 001	200	E	310	8,8	244,5	246	9,1
079 001	250	E	281	8,8	281,1	*	9,1

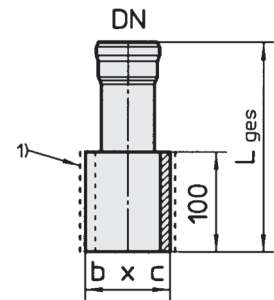

**GM-X weld-on pieces with spigot form F**

Order No.	E 97						
	DN	Form	L [mm]	c [mm]	b [mm]	cut-out [mm]	weight [kg]
081 001	40	F	210	8,8	48,3	60	1,3
082 001	50	F	210	8,8	76,1	77	1,7
083 001	70	F	210	8,8	95,0	96	2,1
084 001	80	F	210	8,8	127,0	128	3,1
085 001	100	F	210	8,8	133,0	134	3,1
086 001	125	F	230	8,8	168,3	170	4,4
087 001	150	F	230	8,8	193,7	195	5,1
088 001	200	F	310	8,8	244,5	246	8,9
089 001	250	F	281	8,8	281,1	*	9,1

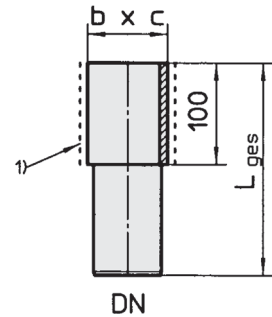

**GM-X Deck- and bulkhead penetrations in accordance to DIN 86288**

Following special fittings are available on request

Order No. E 97							
DN	Form						
	R2B#	R2A#	T2#	T3#	P1#	P1#	P3#
40	041 001*	051 001*	151 001*	061 001*	111 001*	121 001*	131 001*
50	042 001*	052 001*	152 001*	062 001*	112 001*	122 001*	132 001*
70	043 001*	053 001*	153 001*	063 001*	113 001*	123 001*	133 001*
80	044 001*	054 001*	154 001*	064 001*	114 001*	124 001*	134 001*
100	045 001*	055 001*	155 001*	065 001*	115 001*	125 001*	135 001*
125	046 001*	056 001*	156 001*	066 001*	116 001*	126 001*	136 001*
150	047 001*	057 001*	157 001*	067 001*	117 001*	127 001*	137 001*
200	048 001*	058 001*	158 001*	068 001*	118 001*	128 001*	138 001*
250	049 001*	059 001*	159 001*	069 001*	119 001*	129 001*	139 001*

**\*Attention**

Please note, that all shaped components with bends may vary due to production-engineering reasons. Design data is available upon request.

<sup>1)</sup> welding area free of galvanized coating

\* Parts available only on request

Vacuum installation in DN 40, DN 50, DN 70 with special GM-X-VACplus sealing element and standard x-socket piping system

**GM-X socket flange without mating flange form M1 in accordance to DIN 86288**

**PN 6 DIN 2631 PN 10 DIN 2632 PN 16 DIN 2633 VG-flange on request**

Order No.	E 97					
	DN	Form	PN [bar]	L [mm]	k [mm]	weight [kg]
091 001	40	M1	6	100	100	1,3
092 001	50	M1	6	115	110	1,5
093 001	70	M1	6	128	130	2,0
094 001	80	M1	6	127	150	3,2
095 001	100	M1	6	140	170	3,9
096 001	125	M1	6	148	200	6,1
097 001	150	M1	6	153	225	6,4
098 001	200	M1	6	200	280	10,7
099 001	250	M1	6	241	335	14,9
091 002	40	M1	16	79	110	2,0
092 002	50	M1	16	122	125	2,7
093 002	70	M1	16	110	145	3,4
094 002	80	M1	16	135	160	4,2
095 002	100	M1	16	147	180	5,3
096 002	125	M1	16	155	210	7,5
097 002	150	M1	16	155	240	9,1
098 002	200	M1	10	207	295	14,5
099 002	250	M1	10	249	350	18,8

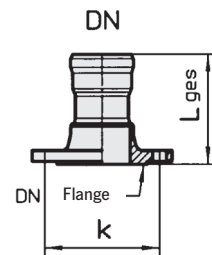

**GM-X spigot flange without mating flange form M2 in accordance to DIN 86288**

**PN 6 DIN 2631 PN 10 DIN 2632 PN 16 DIN 2633 VG-flange on request**

Order No.	E 97					
	DN	Form	PN [bar]	L [mm]	k [mm]	weight [kg]
101 001	40	M2	6	103	100	1,3
102 001	50	M2	6	104	110	1,5
103 001	70	M2	6	133	130	2,1
104 001	80	M2	6	147	150	3,1
105 001	100	M2	6	166	170	3,9
106 001	125	M2	6	198	200	5,8
107 001	150	M2	6	228	225	7,0
108 001	200	M2	6	257	280	11,5
109 001	250	M2	6	241	335	14,7
101 002	40	M2	16	107	110	2,0
102 002	50	M2	16	111	125	2,7
103 002	70	M2	16	140	145	3,4
104 002	80	M2	16	155	160	4,1
105 002	100	M2	16	173	180	5,4
106 002	125	M2	16	205	210	7,8
107 002	150	M2	16	235	240	9,5
108 002	200	M2	10	264	295	13,7
109 002	250	M2	10	249	350	18,64

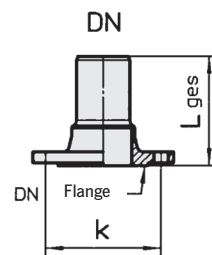

Vacuum installation in DN 40, DN 50, DN 70 with special GM-X-VACplus sealing element and standard x-socket piping system

**Deck and bulkhead penetrations**

**GM-X socket flange without mating flange ANSI flange B 16.5 150 lb/sq.in**

PN 6 DIN 2631 PN 10 DIN 2632 PN 16 DIN 2633

Order No.	E 97					
	DN	Form	PN [bar]	L [mm]	k [mm]	weight [kg]
161 001	40	M1	6	99	98,4	1,5
162 001	50	M1	6	111	120,6	2,4
163 001	70	M1	6	140	152,4	3,9
164 001	80	M1	6	155	177,8	5,4
165 001	100	M1	6	171	190,5	6,5
166 001	125	M1	6	194	215,9	7,8
167 001	150	M1	6	193	241,3	9,8
168 001	200	M1	6	262	298,4	16,8
169 001	250	M1	6	*	*	*

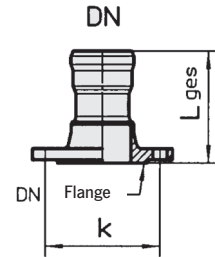

**GM-X spigot flange without mating flange ANSI flange B 16.5 150 lb/sq.in**

PN 6 DIN 2631 PN 10 DIN 2632 PN 16 DIN 263

Order No.	E 97					
	DN	Form	PN [bar]	L [mm]	k [mm]	weight [kg]
171 001	40	M2	6	110	98,4	1,5
172 001	50	M2	6	130	120,6	2,4
173 001	70	M2	6	160	152,4	3,7
174 001	80	M2	6	155	177,8	5,7
175 001	100	M2	6	197	190,5	6,1
176 001	125	M2	6	194	215,9	8,1
177 001	150	M2	6	194	241,3	9,8
178 001	200	M2	6	247	298,4	16,4
179 001	250	M2	6	*	*	*

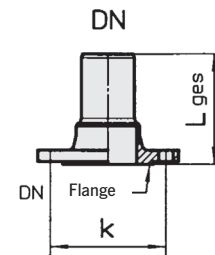

**Deck and bulkhead penetrations passing through main vertical fire zone boundaries**

**GM-X Deck and bulkhead penetrations form T1S in accordance to DIN 86288**

Order No.	DN	Form	E 97					weight [kg]
			L [mm]	c [mm]	b [mm]	cut-out [mm]		
181 001	40	T1S	275	8,8	88,9	90	2,6	
182 001	50	T1S	290	8,8	88,9	90	2,2	
183 001	70	T1S	310	8,8	108,9	109	3,6	
184 001	80	T1S	320	8,8	133,0	134	4,8	
185 001	100	T1S	330	8,8	152,4	154	5,7	
186 001	125	T1S	360	8,8	193,7	195	7,8	
187 001	150	T1S	380	8,8	244,5	246	10,8	
188 001	200	T1S	480	8,8	298,5	300	18,2	
189 001	250	T1S	*	*	*	*	*	

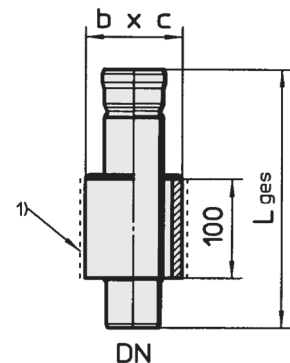

**GM-X Deck and bulkhead penetrations form R1S „Sanitary block“**

Order No.	DN	Form	E 97					weight [kg]
			L [mm]	c [mm]	b [mm]	cut-out [mm]		
221 001	40	R1S	145	8,8	82,5	84	1,6	
222 001	50	R1S	175	8,8	95,0	96	2,0	
223 001	70	R1S	225	8,8	133,0	134	3,5	

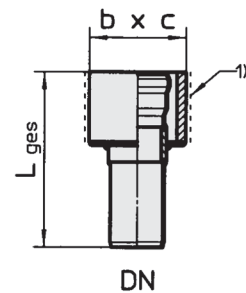

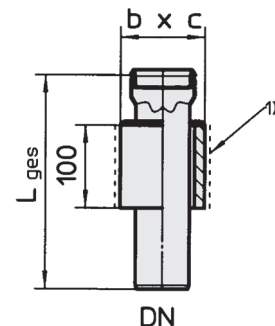

**GM-X Euro-WC deck penetration with sealing element**

Order No.	DN	Form	E 97					weight [kg]
			L [mm]	c [mm]	b [mm]	cut-out [mm]		
235 001	100	J3S	275	8,8	152,4	154	5,3	



**GM-X Deck and bulkhead penetrations in accordance to DIN 86288**

Following special fittings are available on request

Order No.	E 97		
	Form		
			
DN	P1S#	P2S#	T2S#
40	191 001*	201 001*	211 001*
50	192 001*	202 001*	212 001*
70	193 001*	203 001*	213 001*
80	194 001*	204 001*	214 001*
100	195 001*	205 001*	215 001*
125	196 001*	206 001*	216 001*
150	197 001*	207 001*	217 001*
200	198 001*	208 001*	218 001*
250	199 001*	209 001*	219 001*

**\*Attention**

Please note, that all shaped components with bends may vary due to production-engineering reasons. Design data is available on request.

\* Parts available only on request

Vacuum installation in DN 40, DN 50, DN 70 with special GM-X-VACplus sealing element and standard x-socket piping system

**Seals**

	Order No.	040	050	070	080	100	125	150	200	250
		40	50	70	80	100	125	150	200	250
for GM-X pipes	E80 010	✓	✓	✓	✓	✓	✓	✓	✓	✓
for transition to MS-socket 32 mm	E80 100	✓	✓	-	-	-	-	-	-	-
for transition to MS-socket 38 mm and plastic siphon 40 mm	E80 110	✓	✓	-	-	-	-	-	-	-
for transition to MS-socket 48 mm and plastic siphon 50 mm	E80 130	-	✓	-	-	-	-	-	-	-
for transition from KA socket DN 100 to GM-X pipe DN 100	E80 040	-	-	-	-	✓	-	-	-	-
for GM-X pipes (seal set)	E80 015	-	-	-	-	-	-	-	-	✓
for transition to GM-X sockets E80 060 DN 80 to KA pipe DN 80	E80 060	-	-	-	✓	-	-	-	-	-
for transition from GM-X special sockets DN 110 to KA pipe 110 mm	E80 010 110	-	-	-	-	✓	-	-	-	-
for transition from GM-X sockets DN 125 to KA pipe 125 mm	E80 055	-	-	-	-	-	✓	-	-	-
GM-X-VACplus E80 200 for X-socket	E80 200	✓	✓	✓	-	-	-	-	-	-

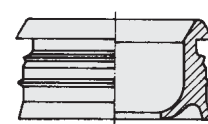
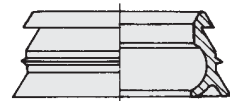
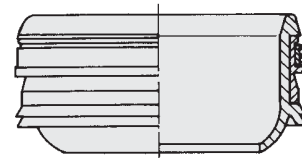



**Pipe clips**

**Pipe clips with knock-in pin without sound-proofing insert**

Order No.	580	
	DN	a
300 040	40	82
300 050	50	95
300 070	70	115
300 080	80	130
300 100	100	150

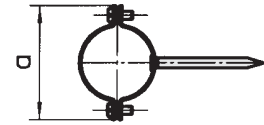

**Pipe clips for threaded pin without sound-proofing insert**

Order No.	580		
	DN	a	G
400 040	40	82	M8
400 050	50	95	M8
400 070	70	115	M8
400 080	80	130	M10
400 100	100	150	M12
400 125	125	185	M12
400 150	150	208	M12
400 200	200	272	M12

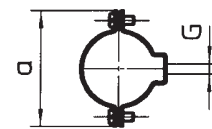

**Pipe clips for threaded pin with sound-proofing insert**

Order No.	580		
	DN	a	G
500 040	40	95	M8
500 050	50	108	M8

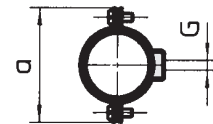

**Pipe clips with weld-on-rod**

Order No.	580	
	DN	a
405 040	40	82
405 050	50	97
405 070	70	120
405 080	80	140
405 100	100	160
405 125	125	190
405 150	150	215

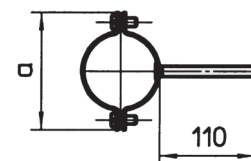

Special configurations available on request.

**Drain plugs**

Steel drain plugs in acc. to EN 1123 form K10

Order No.	DN	570 030				
		d <sub>1</sub>	d <sub>14</sub>	v	s	kg
040	40	42	53	30	1,5	0,11
050	50	53	68	38	1,5	0,16
070	70	73	90	55	1,6	0,30
080	80	89	102	60	1,8	0,45
100	100	102	117	65	2,0	0,54
125	125	133	157	75	2,5	1,05
150	150	159	190	75	2,5	1,43
200	200	219	250	120	2,9	3,45
250	250	273	292	130	4,0	5,21

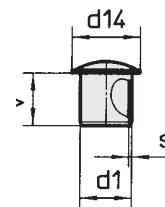

Drain plugs with screwed plug in acc. to EN 1123 form K12

Order No.	DN	570 031			
		d <sub>21</sub>	G	h	kg
040	40	44	M6	26	0,07
050	50	52	M6	28	0,10
070	70	71,5	M8	28	0,20
100	100	105,5	M12	32	0,50
125	125	138	M12	39	0,70
150	150	160	M12	39	1,00

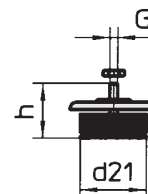

**Accessories**

Plastic protective socket caps

Order No.	580 201					
	040	050	070	100	125	150
DN	40	50	70	100	125	150



Lubricant in tubes 150 g

Order No.	E 80 350 000
-----------	--------------



Lubricant in bucket 1 kg

Order No.	E 80 350 001
-----------	--------------



Bonding agent for seals 125 cm<sup>3</sup>

Order No.	E 80 365 000
-----------	--------------



**Accessories**

**Securing clips against axial thrust and for suspending the pipes in acc. to EN 1123**

Order No.	DN	Form	DIN 19530	570		
				d	h	Weight [kg]
033 040	40	K1	K1	85	49	0,2
033 050	50	K1	K1	98	60	0,3
033 070	70	K1	K1	135	69	0,5
033 080	80	K1	K1	150	70	0,8
033 100	100	K2	K2	185	81	1,0
033 125	125	K2	K2	220	90	1,3

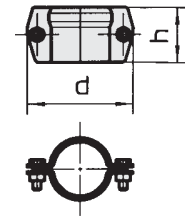

DN 40 - DN 80 with 2 screws      DN 100 and DN 125 with 4 screws

**Securing clips with notched recess for pipe/branch connection in acc. to EN 1123**

Order No.	DN	Form	DIN 19530	570		
				d	h	Weight [kg]
034 040	40	K3	∕.	85	49	0,2
034 050	50	K3	∕.	108	60	0,3
034 070	70	K3	∕.	135	64	0,4
034 080	80	K3	∕.	150	70	0,6
034 100	100	K3	∕.	185	81	1,0
034 125	125	K3	∕.	220	90	1,25

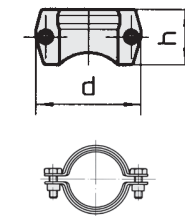

**Securing clamp**

Order No.	DN	Form	570		
			d	h	Weight [kg]
035 150	150	K4	250	154	0,95
035 200	200	K4	300	200	1,2

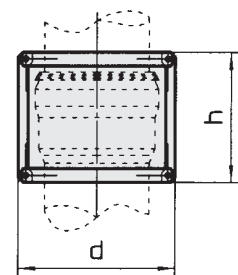

## **Headquarters**

### **ACO Marine s.r.o.**

Nadrazni 72  
CZ - 150 00 Praha 5  
Czech Republic  
Tel.: +420 257 217 990

e-mail: [acomarine@acomarine.com](mailto:acomarine@acomarine.com)  
[www.acomarine.com](http://www.acomarine.com)

© October 2019 ACO Marine. All reasonable care has been taken in compiling the information in this document. All recommendations and suggestions on the use of ACO products are made without guarantee since the conditions of use are beyond the control of the Company. It is the customer's responsibility to ensure that each product is fit for its intended purpose and that the actual conditions of use are suitable. This brochure and any advice is provided by ACO Marine free of charge and accordingly on terms that no liability (including liability for negligence) will attach the Company or its servants or agents arising out of or in connection with or in relation to this brochure or any such advice. Any goods supplied by the Company will be supplied solely upon its standard conditions of sale, copies of which are available on request. The Company's policy of continuous product development and improvement renders specifications liable to modification. Information provided in this brochure is therefore subject to change without prior notification.