

Valid from 11.2019

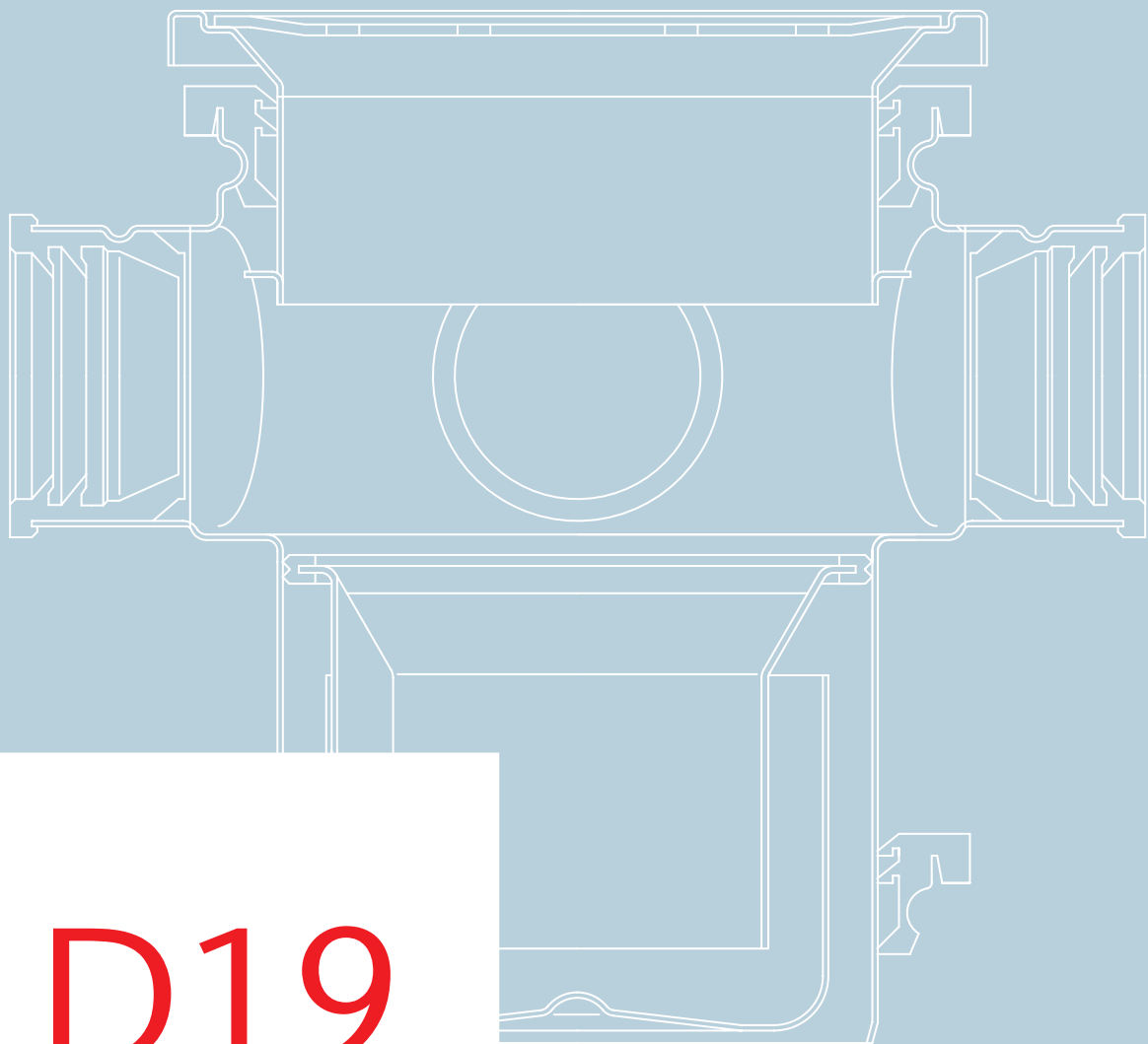





D19

ACO Marine

Product Catalogue  
Marine Drainage



<p><b>Introduction</b></p>	<ul style="list-style-type: none"> <li>■ General introduction</li> <li>■ HygieneFirst</li> <li>■ Hygienic design requirements</li> <li>■ Hygienic design principles</li> <li>■ Material and Surface treatment</li> <li>■ Standards and Certifications</li> <li>■ System overview and benefits</li> <li>■ Drainage selection guide</li> </ul>		<p><b>1</b></p>
<p><b>Internal deck drainage</b></p>	<p>ACO Marine Stainless Steel Scuppers</p> <ul style="list-style-type: none"> <li>■ Introduction - ACO Marine Scuppers</li> <li>■ System overview - ACO one part scuppers 132</li> <li>■ ACO one part scuppers 132</li> <li>■ System overview - ACO two part scuppers 132</li> <li>■ ACO two part scuppers - Lower parts 132</li> <li>■ ACO two part scuppers - Upper parts</li> <li>■ ACO shower scuppers</li> <li>■ Gratings for ACO Marine Scuppers</li> <li>■ Accessories for ACO Marine Scuppers</li> </ul>		<p><b>2</b></p>
	<p>ACO Marine Stainless Steel Channels</p> <ul style="list-style-type: none"> <li>■ Introduction - ACO Marine Channels</li> <li>■ System overview - ACO Marine Channels</li> <li>■ ACO hygienic box channel</li> <li>■ ACO vinyl box channel</li> <li>■ Gratings for ACO Marine Channels</li> <li>■ Accessories for ACO Marine Channels</li> <li>■ ACO Marine Channel - Bespoke Drainage solution</li> <li>■ ACO Design Channel</li> </ul>		<p><b>3</b></p>
	<p>Transport &amp; handling</p> <ul style="list-style-type: none"> <li>■ Transport &amp; handlings</li> </ul>		<p><b>4</b></p>
<p><b>Appendix</b></p>	<p>Cleaning procedures</p> <ul style="list-style-type: none"> <li>■ Introduction</li> <li>■ Principles of cleaning</li> <li>■ Cleaning chemicals</li> <li>■ Manual cleaning of drainage</li> <li>■ Chemical cleaning of drainage</li> <li>■ Overview with recommended cleaning procedures for drainage</li> </ul>		<p><b>5</b></p>
	<p>Typical installation examples</p> <ul style="list-style-type: none"> <li>■ ACO hygienic box channel</li> <li>■ ACO vinyl box channel</li> <li>■ ACO protective covers</li> </ul>		<p><b>6</b></p>
	<p>Material</p> <ul style="list-style-type: none"> <li>■ Resistance of Material</li> <li>■ Sealing material information</li> </ul>		<p><b>7</b></p>
<p><b>Free deck drainage</b></p>	<p>ACO Marine Free Deck Scuppers</p> <ul style="list-style-type: none"> <li>■ Introduction - ACO Marine Free Deck Scuppers</li> <li>■ System overview - ACO Marine Free Deck Scuppers</li> <li>■ ACO scuppers with welded cross</li> <li>■ ACO scupper with flange - hot dip galvanized and internally coated (resin floor)</li> <li>■ ACO scupper with flange - hot dip galvanized (tiled floor)</li> <li>■ ACO scuppers - hot dip stainless steel</li> </ul>		<p><b>8</b></p>

# General introduction

ACO is one of the World's leading drainage specialists with 60 years' experience gained across a wide range of sectors. Our passion for producing high performance products has led us to make major investments in research and development.

Working in partnership with ship owners, managers and operators, as well as with shipyard design departments, we are continuously developing our products and developing our expertise. We understand the critical role that drainage plays in the successful operation of a vessel.

Our product portfolio includes items which are fully compliant with the highest hygienic requirements. We also have a full understanding of the food industry's own standards such as HACCP and we work with bodies including the European Hygienic Engineering and Design Group (EHEDG).

**ACO drainage is used in applications anywhere where hygienic, corrosion resistant and durable drainage performance is essential:**

- Professional galley
- Food processing facilities
- Chilled provision rooms and freezers
- Restaurants
- Hospitals
- Accommodation areas
- and others



## HygieneFirst

As one of the World's leading marine drainage specialists, ACO Marine understands the critical role that drainage plays in a successful commercial food preparation business. We appreciate that food safety, hygiene and cost control are all vital factors, yet we also understand that for many, drainage is out of sight and out of mind.

As a result, many drainage systems are poorly designed leading to inefficiencies and costly on going cleaning and maintenance. In the worst case scenario it can result in food contamination, closure of a galley food preparation area or even detention of the vessel.

As the company that's driving the future of drainage, at ACO we are determined to change this by raising the profile of hygienic drainage and improving standards across every part of the process.

Our HygieneFirst philosophy represents our commitment to delivering products that provide ultimate hygienic performance. We design intelligent drainage solutions that minimize operational costs without compromising food safety.

# Hygienic design requirements

ACO offers sustainable, integrated drainage systems which are designed to protect business, the environment and ultimately public health.

ACO offers sustainable, integrated drainage systems which are designed to protect business, the environment and ultimately public health. Our aim is to constantly improve every aspect of safety, hygiene and functional performance. We believe that our systems and services are truly unique, delivering unparalleled benefits to everyone involved in project delivery or subsequent operation.

ACO hygienic drainage fulfils stringent hygienic requirements to prevent harmful bacteria contamination. We apply relevant hygienic design principles that are reserved for food contact surfaces EN 1672 and EN ISO 14159 to the design of our drainage products.

1

## Hygienic design

---

- Full drainability
    - The outlet is in lowest position.
    - Sleek slope functionality provides a fully drainable solution.
  - Round internal corners
    - Minimum radius of internal corners is 3 mm.
  - Hygienic joints
    - Butt welds are fully welded.
    - Metal-to-metal contact at non-disassembled joints is avoided.
    - Sealed joints are designed to prevent accumulation of soil and bacteria.
  - Edge in-fill
    - The channel frame edge is filled with a waterproof material.
- 

## Material

---

- Stainless steel grade min. AISI 304 according to EN 10088.
  - Fully pickled and passivated or electropolished.
-

# Hygienic design principles

## Hygienic design

All internal radii equal or larger than 3 mm which greatly increases cleaning effectiveness

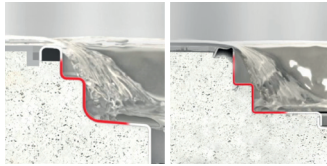

Hygienic joints: deep-drawn body ensures smooth contours eliminating crevices that can harbour dangerous bacteria

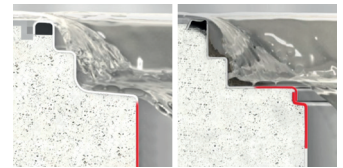

Dry sump design, completely drainable - eliminating stagnant water, smells, microbial growth and potential chemical hazards.

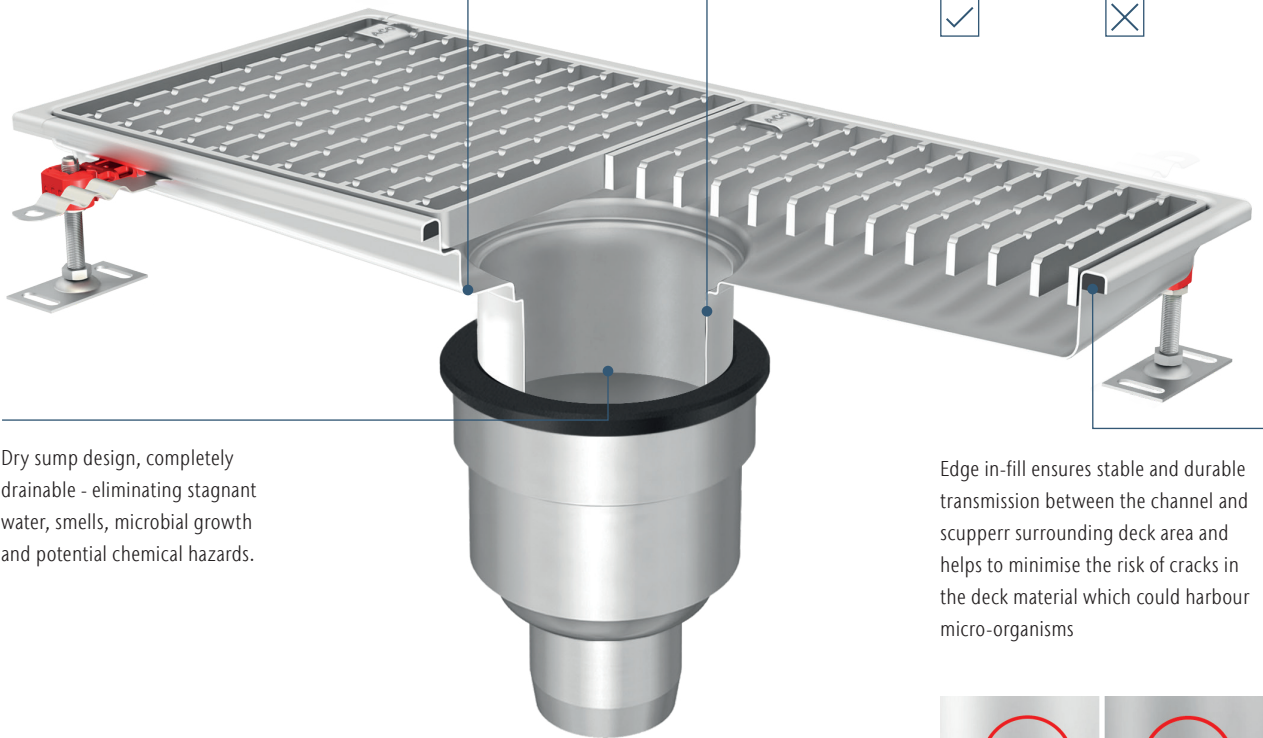

Edge in-fill ensures stable and durable transmission between the channel and scupper surrounding deck area and helps to minimise the risk of cracks in the deck material which could harbour micro-organisms

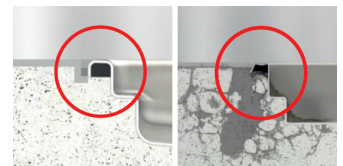

Note: Assembly example pictures.

# Material and Surface treatment

## Stainless Steel

Stainless steel is the name given to a wide range of steels which have the characteristics of greatly enhanced corrosion resistance over conventional mild and low alloy steels. The enhanced corrosion resistance of stainless steel essentially comes from the addition of at least 11% of chromium, however, most commonly used stainless steels contain around 18% of chromium. Other significant alloying elements include nickel and for superior corrosion resistant properties, molybdenum.

### Stainless steel has the following unique advantages:

- High corrosion resistance
- Nonporous, easy to clean and disinfect
- Aesthetically pleasing
- Resistant to extreme temperatures and thermal shock
- 100% recyclable material

**ACO Marine drainage is manufactured from austenitic stainless steel, grades AISI 304 or AISI 316L according to EN 10088** and is ideal for applications including food preparation areas, galley deck drainage systems, provision rooms and freezers.

### Surface treatment

The process cutting, forming and welding of stainless steel will introduce impurities into the surface of the material and unless the appropriate action is taken, the material will begin to corrode and ultimately fail in service. Therefore, after fabrication, it is vital that stainless steel is treated with the correct surface treatment to ensure it is fully corrosion resistant. By applying pickle passivation as the primary surface treatment, the corrosion resistance of stainless steel can be fully restored to its original state, ensuring long and reliable life performance together with the required aesthetic appearance.

## Galvanized Steel

Free deck galvanized steel scuppers are manufactured from welded, one-time cold-drawn precision steel sheet in accordance with DIN 2394.

Tensile strength: Rm 310-410 N/mm<sup>2</sup>  
Elongation at break: A5 min. 28%

### Finishes used by ACO include:

#### Pickle passivation (acid treatment)

All ACO drainage is pickle passivated by immersing products in a series of acid baths. This is a fundamental requirement for removing iron embedded particulates introduced in the fabrication process and also for restoring the chromium depleted regions generated by the welding process. ACO has one of the largest and most advanced pickle passivation installations in Europe which ensures the optimum corrosion resistance of our products.

#### Electropolishing (electrochemical process)

After pickle passivation, some products are then immersed in an electrolytic fluid in which the products become the anode of a direct current electrical circuit. This process is characterized by a selective attack of the surface of the components whereby upstanding roughness is preferentially dissolved and will yield a progressively smoother, brighter surface. All hygienic box channel grates are electro-polished as a standard.

#### Brushing (mechanical process)

ACO Marine channels have a brushed upper edge for aesthetic reasons.

# Standards and Certifications

## ACO Marine Scuppers and Channels

ACO Marine Scupper and Channel ranges are designed, manufactured, tested and certified in accordance with EN 1253. We apply the relevant hygienic design principles in accordance with EN 1672 and EN ISO 14159.

### Benefits

ACO Marine provides solutions which optimise food safety, employee's health and safety as well as protection of the water and the environment.

Every ACO product safely controls the water to ensure that it can be hygienically, economically and ecologically managed in a viable way.

#### 1 Internal deck drainage



ACO Marine  
Stainless Steel Scuppers

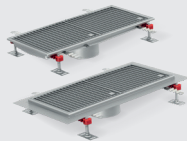

ACO Marine  
Stainless Steel Channels

#### 2 Free deck drainage



ACO Marine  
Free Deck Scuppers

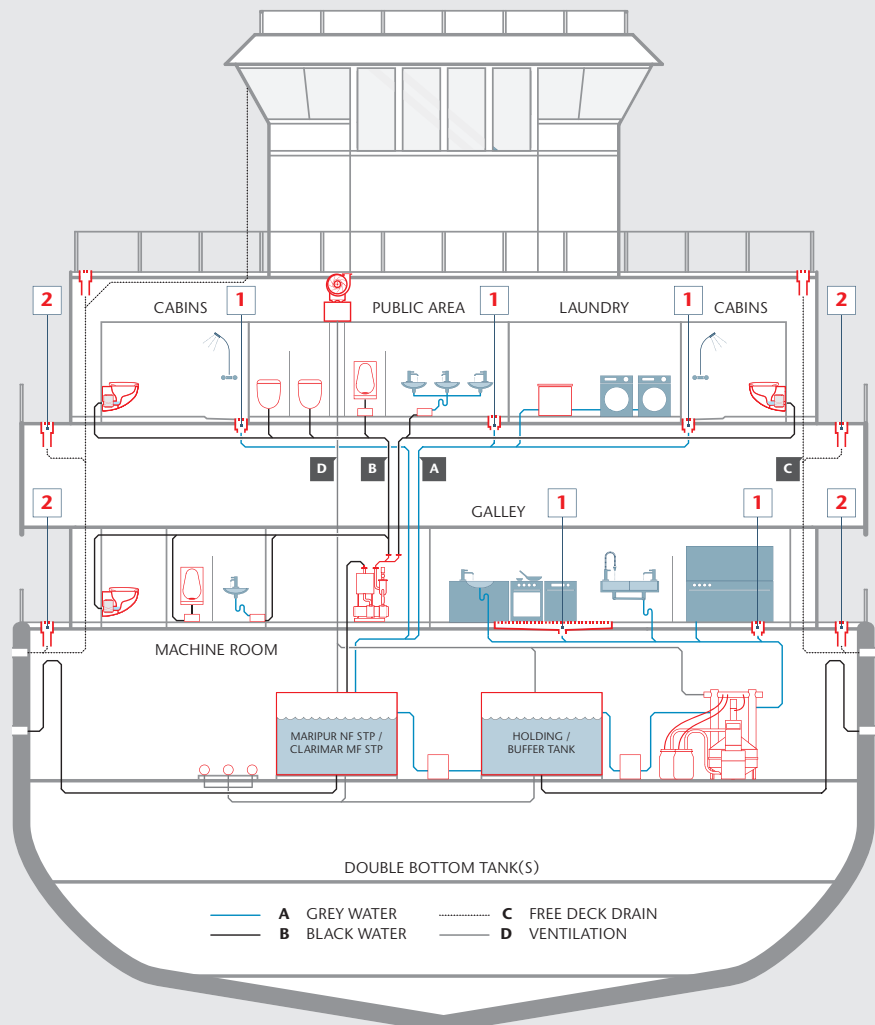



# System overview and Benefits

## Food safety

- ACO Marine hygienic drainage fulfills hygienic requirements to prevent harmful bacteria contamination. We apply relevant hygienic design principles reserved for food contact surfaces as recommended by EHEDG.
- Our product design ensures minimal build-up of food particles and debris as well as a safe connection with the surrounding deck material to minimise any opportunity for bacteria to grow throughout the drainage system.
- Sleek slope function and hygienically designed products ensure our system is fully drainable, eliminating the stagnant odour of waste water.

## Cost control

- ACO Marine drainage systems can be easily maintained, reducing associated cleaning costs, thanks to their functional design and cleaning recommendations which have been developed in partnership with premium cleaning agent suppliers.
- ACO Marine's advanced manufacturing technologies ensure durability and our special surface treatment guarantees corrosion resistance. Our systems perform effectively at all times and keep as well as protection of the water and the environment disruption to a minimum.
- We provide expertise in drainage system planning, correct installation and creating a safe connection with the surrounding floor to avoid unnecessary costs.

## Health & Safety

- For additional safety in high risk areas that require heavy water usage, a slip resistant grating is available.
- Each component of the drainage system is easy to remove and clean, and there are no sharp edges for optimum crew safety.

# Drainage selection guide

## Drainage type

Drainage options are selected according to galley and workspace layout, together with the type of equipment being utilised within the compartment.

**Point drainage**

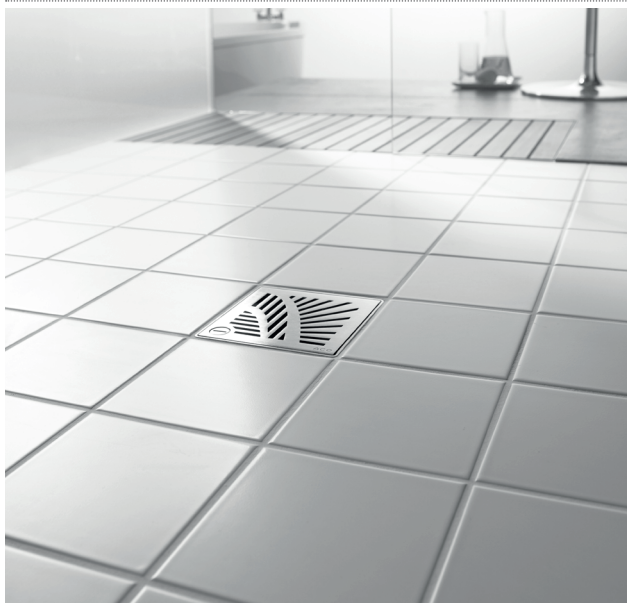

**Linear drainage**



## Material resistance

The chemical mixture of the waste water from the process and/or from the cleaning as well as temperature of the final mixture influences the material resistance of the drainage system.

**ACO Marine drainage is manufactured from austenitic stainless steel, grades AISI 304 or AISI 316L** and it is ideal for food preparation areas, galley deck drainage systems, provision rooms and freezers.

Besides stainless steel, drainage products also contain sealing materials:







**ACO Marine Scuppers** – all the seals are made of NBR (acryl nitrile-butadiene rubber)

**ACO Marine Channels** – flange connection seals are made of NBR (acryl nitrile-butadiene rubber)

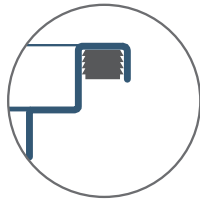
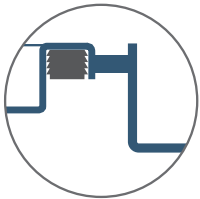
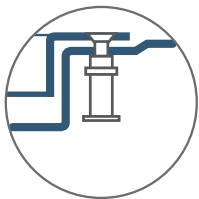
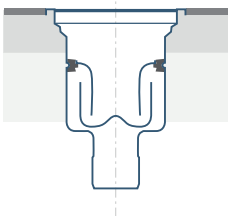
For details of material resistance see page 52 or contact our Sales/Technical department.

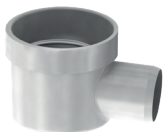
## Channel edge selection depending on the floor type

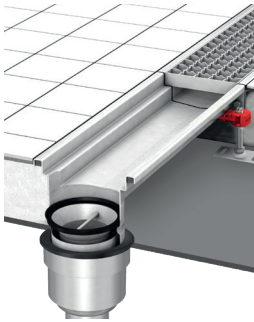
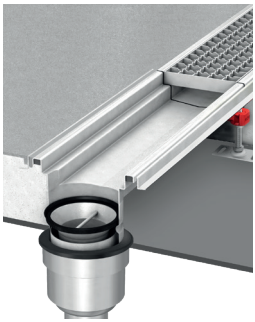
Depending on the floor type; the appropriate type of scupper body or channel should be selected.

	Channel + Scupper body			One part scupper
Deck finish	Tiled or resin floor	Resin floor	Vinyl floor	Tiled, resin or "direct deck floor"
Channel or scupper edge	Standard edge	L-profile edge	Vinyl edge	Standard edge
Channel or scupper top drawing				
Scupper - lower part type	With welding sleeve or welding flange			One part scupper
Scupper - lower part picture				
Installation example				

# Drainage selection guide

## Retention capacity

Depending on the application, the appropriate retention capacity should be considered.

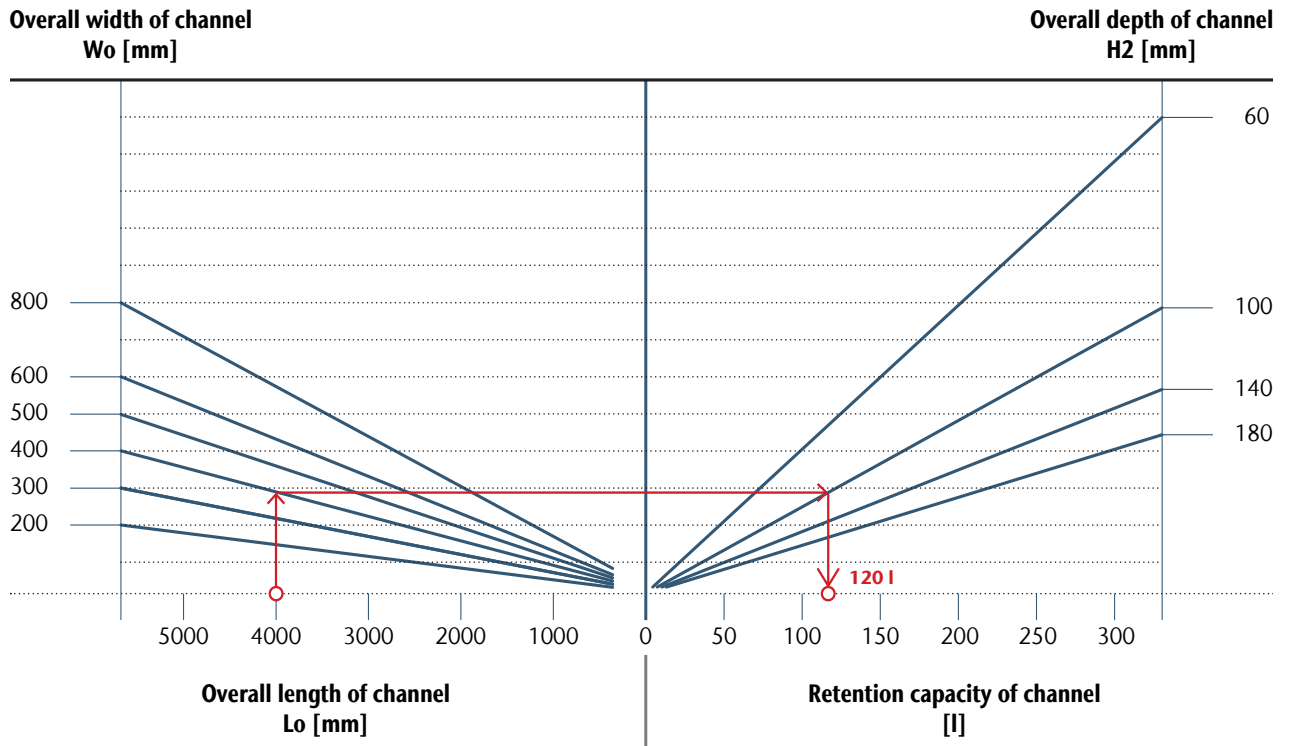

Example: channel length 4000mm, width 400mm, depth 100mm, retention capacity 120 l.

## Channel geometry

Based on the retention capacity considered, as well as the deck structure, the particular dimensions of a channel or scupper - upper part (for telescopic solution) need to be

specified. For the channel a construction height at the outlet position as well as the position of the outlet and the height of the endcaps has to be defined.

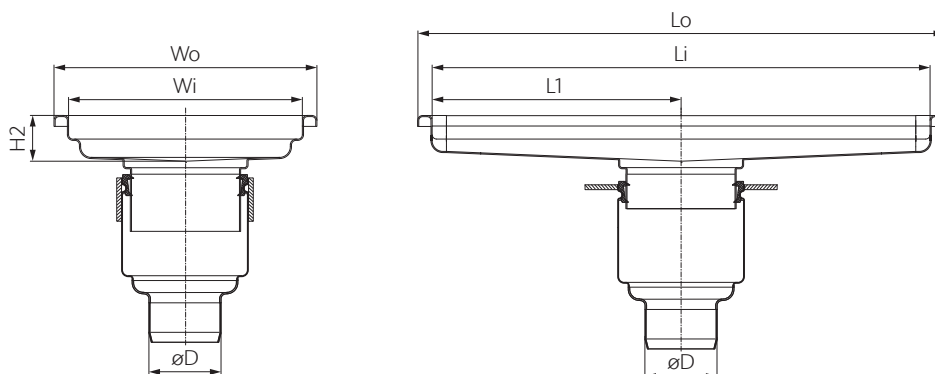

## Gratings

For selecting the appropriate grating, the following properties have to be considered:

- Hygiene (cleanability)
- Slip resistant
- Load class

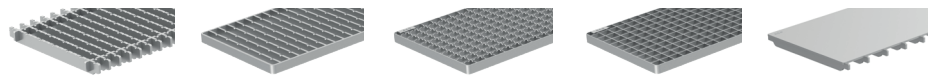





ACO grating type	ACO frameless ladder grating	ACO hygienic ladder grating	ACO mesh grating		ACO slot cover
	Slip resistant	Slip resistant	Slip resistant	Plain	Plain
Surface	electropolished	electropolished	electropolished	electropolished	sand blasted top
Cleanability	Excelent	Good	Sufficient	Sufficient	Good
Slip resistance	Yes	Yes	Yes	No	Yes
Potential for slip according to BS 7976-2 (Pendulum test)	Low	Low	Low	Moderate	Low
Slip resistance classification acc. to DIN 51130 (Ramp test)	R11	R11	R11	R9	R11
Load class availability acc. to EN 1253 for scuppers	M 125	R 50; M 125; N 250	L 15	L 15	R 50; M 125
Load class availability acc. to EN 1253 for channels	M 125	R 50; M 125; N 250	L 15	L 15	R 50; M 125; N 250

## Load class standards

Though it is recommended to avoid traffic across the drainage system, to minimize the risk of floor/drainage connection failures from dynamic loading, the proper

load class defined by the grating has to be considered based on the defined traffic during all future operations.

Load class Application	Load class according to EN 1253	Description
	K 03	■ Areas loaded by weight of one person, typically in private premises, such as bath rooms, shower boxes, toilets, etc.
	L 15	■ Pedestrian public areas without vehicular traffic, such as pedestrian corridors, small galleys, etc.
	R 50	■ Areas with light vehicular traffic, e.g. trolleys and carts without an engine, pulled or pushed by operator
	M 125	■ Areas with medium vehicular traffic, e.g. trolleys and carts with their own engine
	N 250	■ Heavy duty areas, e.g. with forklift traffic

# Flow rates and construction heights

Flow rates reflect the system's ability to constantly drain a certain amount of water.

## Outlet position - Vertical

### ACO Marine Scuppers

### ACO Marine Channels

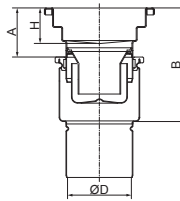
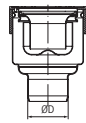

Notes:

Flow rates measured according to EN 1253.

Flow rate performance without sieve or silt basket (flow rates with empty sieve or silt basket are approximately 15% lower than the values stated).

Outlet diameter $\varnothing D$	Flow rate [l/s]	Flow rate [l/s]	
		H = 60 mm	
		A min. = 60 A max. = 85 B min. = 165 B max. = 190	
75	1.2	1.3	1.5
110	1.2	1.3	1.5

## Outlet position - Horizontal

### ACO Marine Scuppers

### ACO Marine Channels

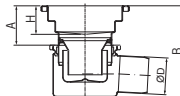
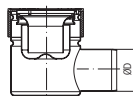

Notes:

Flow rates measured according to EN 1253.

Flow rate performance without sieve or silt basket (flow rates with empty sieve or silt basket are approximately 15% lower than the values stated).

Outlet diameter $\varnothing D$	Flow rate [l/s]	Flow rate [l/s]	
		H = 60 mm	
		A min. = 60 A max. = 85 B min. = 165 B max. = 190	
75	1.2	1.3	1.5

# Accessories

For the collection of solid parts, the scupper or channel should be fitted with a sieve (optionally with a silt basket).

1



2

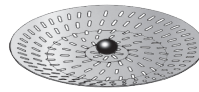

## Accessories

- 1 Foul air trap
- 2 Sieve



2

## Internal deck drainage

**COLLECT:**  
Collect and remove





chapter	section	heading		
<b>Internal deck drainage</b>	ACO Marine Stainless Steel Scuppers	Introduction - ACO Marine Scuppers	18	
		System overview - ACO one part scuppers 132	19	
		ACO one part scuppers 132	20	
		System overview - ACO two part scuppers 132	21	
		ACO two part scuppers - Lower parts 132	22	
		ACO two part scuppers - Upper parts	23	
		ACO shower scuppers	25	
		Gratings for ACO Marine Scuppers	26	
		Accessories for ACO Marine Scuppers	28	
		ACO Marine Stainless Steel Channels	Introduction - ACO Marine Channels	30
			System overview - ACO Marine Channels	31
			ACO hygienic box channel	32
			ACO vinyl box channel	33
			Gratings for ACO Marine Channels	34
Accessories for ACO Marine Channels	35			
ACO Marine Channel - Bespoke Drainage solution	36			
<b>Appendix</b>	Transport & handlings	Transport & handlings	42	
	Cleaning procedures	Introduction	44	
		Principles of cleaning	45	
		Cleaning chemicals	46	
		Manual cleaning of drainage	47	
		Chemical cleaning of drainage	48	
	Typical installation examples	Overview with recommended cleaning procedures for drainage	49	
		ACO hygienic box channel	50	
		ACO vinyl box channel	51	
	Material	ACO protective covers	51	
Resistance of Material		52		
	Sealing material information	53		



# Introduction - ACO Marine Scuppers

ACO Marine has designed a wide range of multi-application, high performance stainless steel floor scuppers.

The ACO Marine Scuppers range is designed to provide hygienic, quick, simple and economic trapped drainage solutions for washrooms, toilets, 'wet' bathrooms, changing rooms, galleys, swimming pools, etc.

All floor finishes, including all resin screeds, ceramic tiles, flexible vinyl sheet in solid and suspended flooring applications are catered for.

Manufactured from austenitic 304 grade stainless steel as standard; excellent corrosion resistance is guaranteed. Optional 316L grade stainless steel for aggressive applications is available in all scuppers.

Additional features include compact design, removable in-line foul air trap is fitted as standard, with a choice of vertical or horizontal spigot outlets, telescopic height adjustment and full rotational adjustment for tiles, wall or equipment alignment.

Optional side inlet facilities are provided to fit the hand basin and the condensation waste pipes.

## Typical Application

- Washrooms
- Wet bathrooms
- Toilets
- Galleys
- Recreation area
- Swimming pools

## ACO Product Benefits

- Corrosion resistant 304 austenitic stainless steel construction
- 316L austenitic stainless steel option for aggressive environments
- Ultra-compact design ideal for suspended floor applications
- Quick, easy installation in screed, tiled or flexible vinyl flooring finishes
- Foul air trap fitted as standard, flow rate 1.2 l/sec
- Choice of Ø 110, 75 and 50 mm vertical or Ø 75 and 50 mm horizontal spigot outlets
- Foot safe, fitted as standard for pedestrian applications
- Smooth contour design minimises bacteria traps
- Attractive, neat appearance
- Telescopic height variant providing full 360° rotation and +/- 7.5° pitch & roll adjustment
- End stops provided preventing accidental dismantling on telescopic variants
- Three side inlets variants optionally available, supplied with fully interchangeable adaptors to suit 32 mm and 40 mm waste pipes
- Supplied boxed complete with fitting instructions - no loose parts

# System overview

## ACO one part Scuppers 132

### Scuppers - One part

#### Accessories

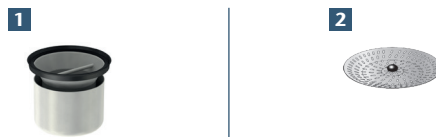

#### Scuppers- One part

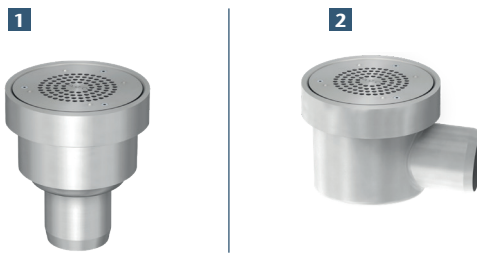

#### Accessories

- 1 Foul air trap
- 2 Sieve

#### Scuppers - One part 132

- 1 Vertical (load class K 3)
- 2 Horizontal (load class K 3)

# ACO one part Scuppers 132

## One part scupper with vertical outlet (load class K 3)

Drawing	D1 [mm]	H1 [mm]	H2 [mm]	Weight [kg]	Foul air trap	Material	Part no.
	50	50	125	1.50	With	AISI 304	446464
						AISI 316L	446465
		Without	AISI 304	446466			
			AISI 316L	446467			
	75	50	125	1.65	With	AISI 304	446468
						AISI 316L	446469
		Without	AISI 304	446470			
			AISI 316L	446471			
	110	68	107	1.50	With	AISI 304	446472
						AISI 316L	446473
		Without	AISI 304	446474			
			AISI 316L	446475			

## One part scupper with vertical outlet (load class K 3)

Drawing	D1 [mm]	H1 [mm]	H2 [mm]	Weight [kg]	Foul air trap	Material	Part no.
	50	125	194	1.50	With	AISI 304	446476
						AISI 316L	446477
		Without	AISI 304	446478			
			AISI 316L	446479			
	75	110	200	1.50	With	AISI 304	446480
						AISI 316L	446481
		Without	AISI 304	446482			
			AISI 316L	446483			

# System overview - ACO two part Scuppers 132

## Scuppers - Upper part

Gratings for hygienic upper parts (load class L 15 and more)

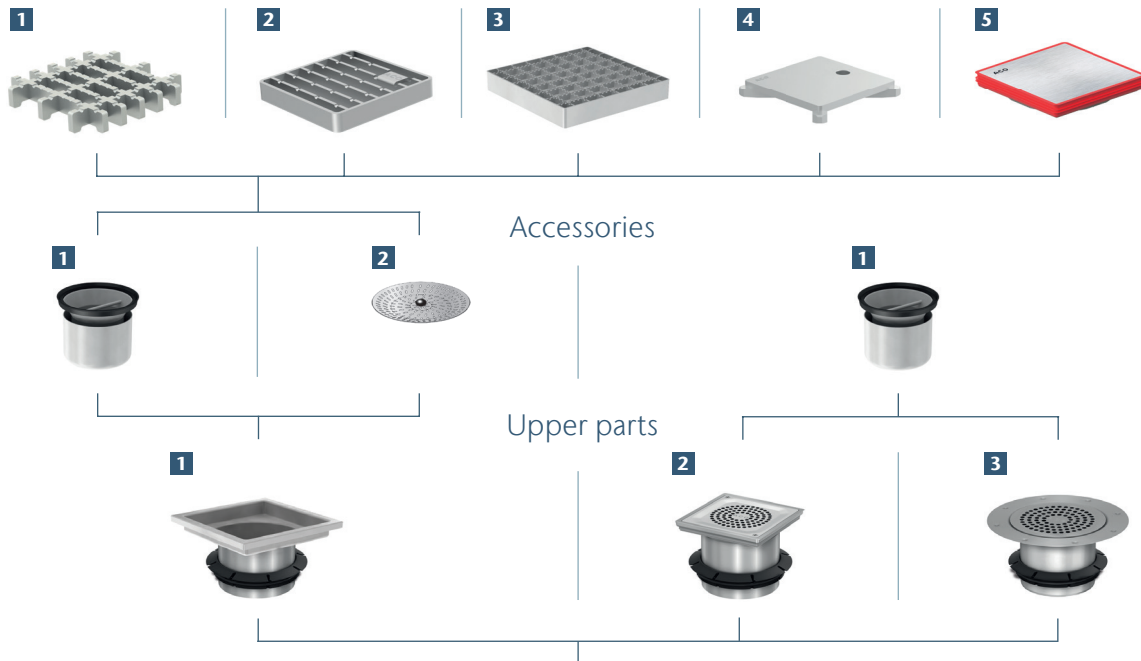

## Scuppers - Lower parts 132

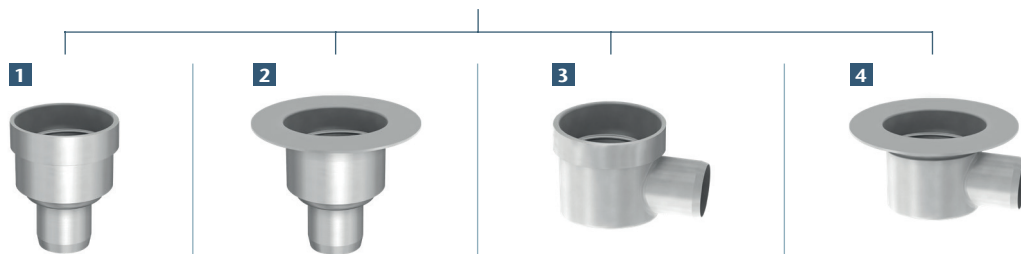

### Accessories for Upper parts

- 1** Foul air trap
- 2** Sieve

### Gratings for hygienic upper parts

- 1** Frameless ladder grating
- 2** Hygienic ladder grating
- 3** Mesh grating
- 4** Hygienic slot cover
- 5** Odour proof gully cover

### Scuppers - Upper parts

- 1** Hygienic upper part for tiled or resin floors (load class L 15 and more)
- 2** Upper part for tiled or resin floors (load class K 3)
- 3** Upper part for vinyl floors (load class K 3)

### Scuppers - Lower part 132

- 1** Vertical with welding sleeve
- 2** Vertical with welding flange
- 3** Horizontal with welding sleeve
- 4** Horizontal with welding flange

# ACO two part scuppers - Lower parts 132

## Lower part with vertical outlet and welding sleeve

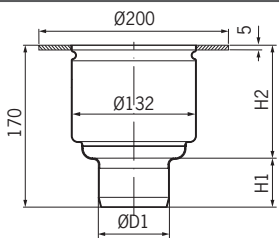
Drawing	D1 [mm]	H1 [mm]	H2 [mm]	Weight [kg]	Material	Part no.
	50	50	120	2.10	AISI 304	446445
					AISI 316L	446446
	75	50	120	2.20	AISI 304	446447
					AISI 316L	446448
	110	68	102	2.30	AISI 304	446449
					AISI 316L	446450

## Lower part with vertical outlet and welding flange

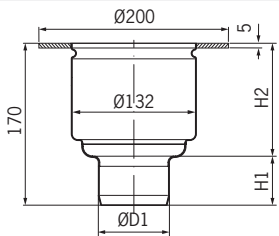
Drawing	D1 [mm]	H1 [mm]	H2 [mm]	Weight [kg]	Material	Part no.
	50	50	120	2.10	AISI 304	446445
					AISI 316L	446446
	75	50	120	2.20	AISI 304	446447
					AISI 316L	446448
	110	68	102	2.30	AISI 304	446449
					AISI 316L	446450

## Lower part with horizontal outlet and welding sleeve

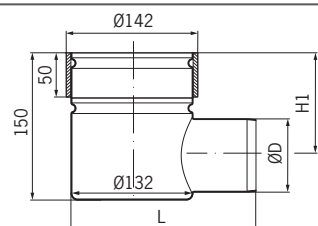
Drawing	D1 [mm]	H1 [mm]	H2 [mm]	Weight [kg]	Material	Part no.
	50	120	194	1.50	AISI 304	446451
					AISI 316L	446452
	75	105	200	1.60	AISI 304	446453
					AISI 316L	446454

## Lower part with horizontal outlet and welding flange

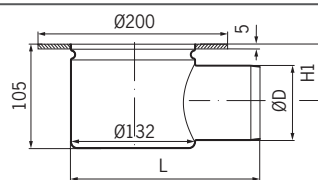
Drawing	D1 [mm]	H1 [mm]	H2 [mm]	Weight [kg]	Material	Part no.
	50	75	194	2.20	AISI 304	446455
					AISI 316L	446456
	75	59	200	2.10	AISI 304	446457
					AISI 316L	446458

**Note:**

In order to avoid any damage to the seal ring between the lower and the upper parts of the scupper through welding, the lower part is delivered without the seal ring. The seal ring is attached to the upper part of the scupper. Before the assembly of the lower and upper parts, it is necessary to correctly insert the seal ring into the lower part of the scupper; according to the following mounting instructions:

1. Remove the seal ring from the spigot end of the upper part of the scupper.
2. Ensure that the seal ring itself and the zone around the lower part of the scupper receiving the seal is clean, dry and free from dust, grit and any metallic particles.

3. Insert the dry seal ring into the lower part of the scupper as shown in the diagram below.

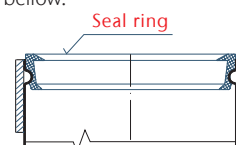

4. When assembling the lower and upper parts of the scupper apply the lubricant (Order No 400520) sparingly to the lips to aid insertion.
5. Do not use any tools to aid the assembly process, otherwise damage to the scupper seal ring may occur.

# ACO two part scuppers - Upper parts

## Hygienic upper part tiled or resin floors (load class L 15 and more)

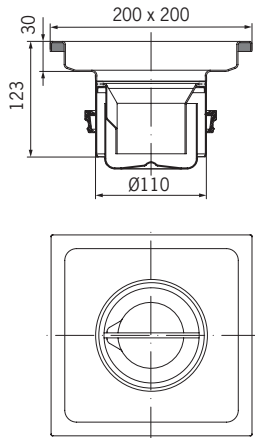
Drawing	Weight [kg]	Foul air trap	Material	Part no.
	1.05	With Foul Air Trap	AISI 304	446459
			AISI 316L	446460

For grates with load class L15 and more, please go to page 26. For more information about optional protective covers see page 51.

## Upper part for tiled or resin floors (load class K 3)

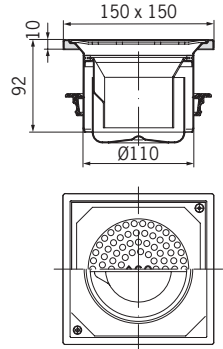
Drawing	Load class	Weight [kg]	Foul air trap	Material	Part no.
	K 03	1.05	With	AISI 304	410090
				AISI 316L	410091
		0.75	Without	AISI 304	410092
				AISI 316L	410093

## Upper part for vinyl floors (load class K 3)

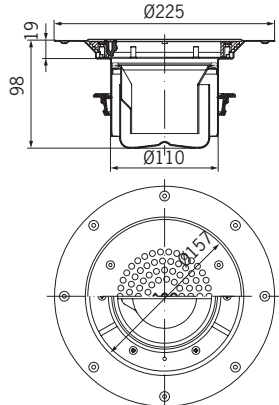
Drawing	Load class	Weight [kg]	Foul air trap	Material	Part no.
	K 03	1.25	With	AISI 304	410094
				AISI 316L	410095
		0.95	Without	AISI 304	410096
				AISI 316L	410097

**Upper part with three side inlets for tiled or resin floors (load class K 3)**

Drawing	Weight [kg]	Foul air trap	Material	Part no.
	2.05	WWith	AISI 304	410102
			AISI 316L	410103
	1.75	Without	AISI 304	410104
			AISI 316L	410105

Note: Side inlet diameters available in 32 and 40 mm.

Note:

In order to avoid any damage to the seal ring between the lower and the upper parts of the scupper through welding, the lower part is delivered without the seal ring. The seal ring is attached to the upper part of the scupper. Before the assembly of the lower and upper parts, it is necessary to correctly insert the seal ring into the lower part of the scupper; according to the following mounting instructions:

1. Remove the seal ring from the spigot end of the upper part of the scupper.
2. Ensure that the seal ring itself and the zone around the lower part of the scupper receiving the seal is clean, dry and free from dust, grit and any metallic particles.
3. Insert the dry seal ring into the lower part of the scupper as shown in the diagram below.

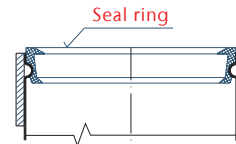

4. When assembling the lower and upper parts of the scupper apply the lubricant (Order No 400520) sparingly to the lips to aid insertion.
5. Do not use any tools to aid the assembly process, otherwise damage to the scupper seal ring may occur.



# ACO shower scuppers

## ACO shower scuppers (load class K 3)

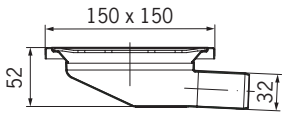
Drawing	Weight [kg]	Material	Part no.
	0.70	AISI 304	400791
		AISI 316L	400792

# Gratings for ACO Marine Scuppers

## Product information

Variety of grate types is available depending on application and requested load class. For applications with high hygienic demands ladder grate or cast grate should be selected.

### HygieneFirst features

- Hygienic design following EN 1672, EN ISO 14159
- Available in 1.4301 (304) or 1.4404 (316L) grades of stainless steel
- Fits to stainless steel gully, fully compliant to: EN 1253 and NSF International
- Fully pickled and passivated
- Gully top frame size: 200 x 200 mm
- Range of gratings suitable to load classes: L 15, R 50, M 125 or N 250 (EN 1253)
- Slip resistant solution available

### ACO frameless ladder grating

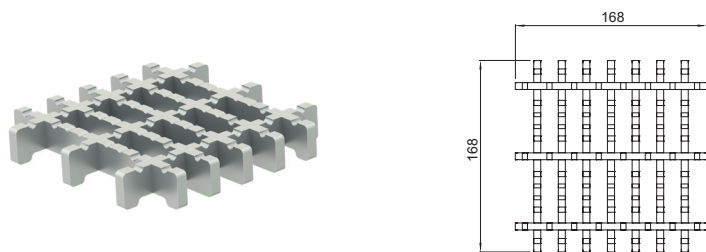

Load class	Slip resistant	Material	Part no.
M 125	Yes	AISI 304	446264
		AISI 316L	446265

Note: Surface electropolished

### ACO hygienic ladder grating

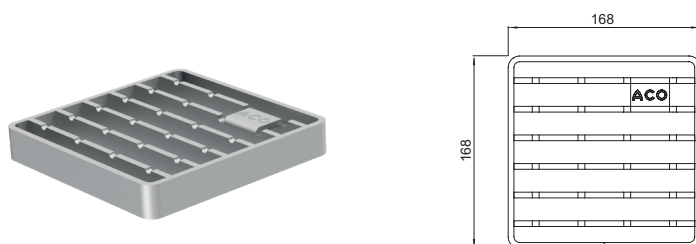

Load class	Slip resistant	Material	Part no.
R 50	Yes	AISI 304	416912
		AISI 316L	416913
M 125	Yes	AISI 304	408093
		AISI 316L	408193
N 250	No	AISI 304	408043
		AISI 316L	408143

Note: Surface electropolished

### ACO mesh grating

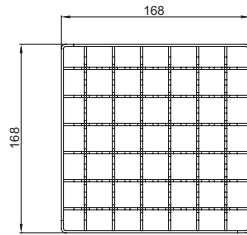
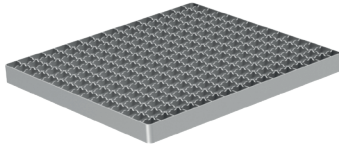

Load class	Slip resistant	Material	Part no.
L 15	Yes	AISI 304	408090 *
		AISI 316L	408190 *
	No	AISI 304	408091 *
		AISI 316L	408191 *

Note: Surface electropolished

### ACO hygienic slot cover

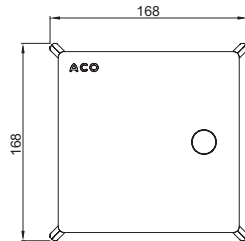

Load class	Slip resistant	Material	Part no.
R 50	Yes	AISI 304	<b>445780</b>
		AISI 316L	<b>445781</b>
M 125	Yes	AISI 304	<b>445782</b>
		AISI 316L	<b>445783</b>

Note: Top surface sandblasted

### ACO odour proof gully cover

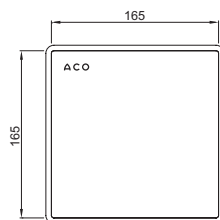





Load class	Slip resistant	Material	Part no.
R 50	No	AISI 304	445398 *
M 125	No	AISI 316L	445605 *

Note: For ACO vacuum handle, please go to page 28.

Note:

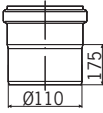
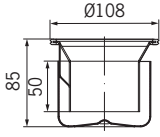
\* Hygienic design following EN 1672, EN ISO 14159 not applied.

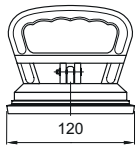
## Accessories for ACO Marine Scuppers

	Description	Weight [kg]	Material	Part no.
	<ul style="list-style-type: none"> <li>Extension pipe Stainless steel</li> </ul>	0.35	AISI 304	410136
			AISI 316L	410137
	<ul style="list-style-type: none"> <li>Foul air trap</li> <li>Stainless steel</li> <li>Upper part</li> </ul>	0.30	AISI 304	97217
			AISI 316L	97267
	<ul style="list-style-type: none"> <li>Sieve (optional)</li> <li>Stainless steel</li> </ul>	0.10	AISI 304	97235
			AISI 316L	97285
	Lubricant 500 ml	0.60	NBR	400520
	<ul style="list-style-type: none"> <li>ACO vacuum handle</li> <li>ACO odour proof gully cover</li> </ul>		Aluminium	445622
	Seal for ACO scuppers - lower part 132		NBR	E63772

### P-trap

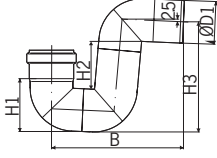
	P- trap dimension					Weight [kg]	Material	Part no.
	D1 [mm]	H1 [mm]	H2 [mm]	H3 [mm]	B [mm]			
	50	68	78	149	187	0.50	AISI 304	98822
							AISI 316L	98872
	75	94	86	193	232	0.70	AISI 304	98824
							AISI 316L	98874
	110	132	95	254	300	1.30	AISI 304	98826
							AISI 316L	98876



# Introduction - ACO Marine Channels

## ACO Marine channel portfolio

The ACO Marine channel range includes channels for all common applications and all common floor types (tiles, resin or vinyl). The ACO Marine channel portfolio is designed with respect to hygienic design requirements. Selecting a channel from the range is easy.

The unique variability of the whole portfolio makes it easy to choose a channel that suits a customer's specific needs. Channel length, depth and outlet position are just a few of the parameters which can be varied and, regardless of the variations specified, there is no impact on delivery lead times.

## ACO Marine channel ordering

The dimensions of the ACO Marine channel can be easily specified in respect of project requirements. To specify the channel please use the Customization template (see page 36) which will help you to identify the information

you need, or contact our Sales/Technical department. ACO Marine channels with fixed dimensions are also available. These dimensions are a selection of most frequently sold ACO Marine channels.

## ACO Marine channel customization

In addition all ACO Marine channels can be designed with:

- Special outlet position
- Special depth
- Special slope
- Special channel width
- L-shape and T-shape lay out
- Special side inlets

To ask for customised ACO Marine channel, please contact our Sales/technical department. Please take into consideration that ACO Marine channel customization could decrease the number of hygienic design features.

# System overview - ACO Marine Channels

## Marine Channel - Telescopic solution

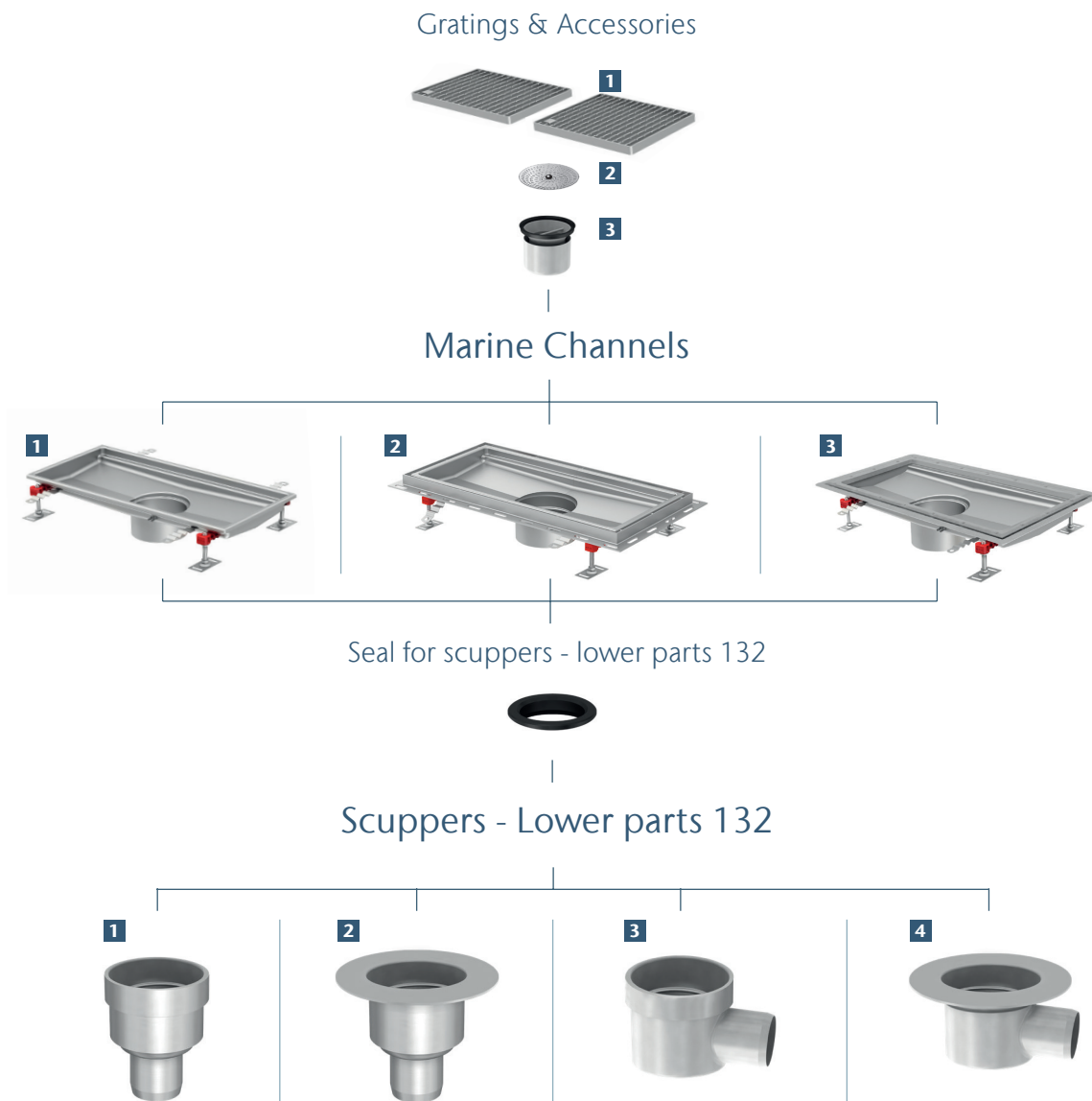

### Gratings for Marine Channels

- 1** Frameless ladder grating
- 2** Hygienic ladder grating
- 3** Mesh grating
- 4** Hygienic slot cover

### Accessories for Marine Channels

- 1** Foul air trap
- 2** Sieve

### Marine Channels

- 1** ACO hygienic box channel - Standard edge
- 2** ACO hygienic box channel - L-profile edge
- 3** ACO vinyl box channel - Vinyl edge

### Scuppers - Lower part 132

- 1** Vertical with welding sleeve
- 2** Vertical with welding flange
- 3** Horizontal with welding sleeve
- 4** Horizontal with welding flange

# ACO hygienic box channel

## Standard edge

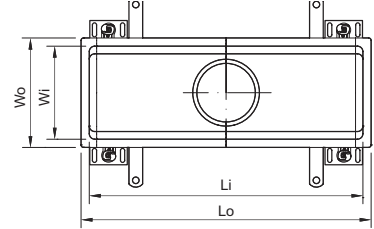
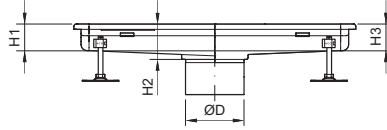
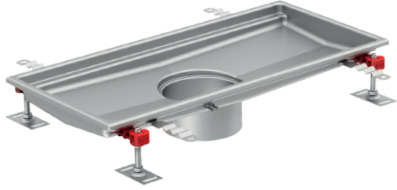

External (overall) width	Internal (grating) width	Length of channel	Height at outlet of channel	Height at end of channel
Wo [mm]	Wi [mm]	Lo	H2	H1 and H3
150	120	Variable *	50-200	50, 80, 110, 140
200	170			
300	270			

Note: \* Longer channels over 6 m in length are supplied, as standard, divided into sections up to 6 m long with transport joints.

## L-profile edge

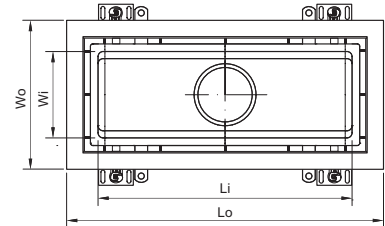
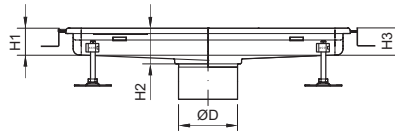

External (overall) width	Internal (grating) width	Length of channel	Height at outlet of channel	Height at end of channel
Wo [mm]	Wi [mm]	Lo	H2	H1 and H3
185	120	Variable *	50-200	50, 80, 110, 140
235	170			
365	270			

Note: \* Longer channels over 6 m in length are supplied, as standard, divided into sections up to 6 m long with transport joints.  
For more information about optional protective covers see page 51.



# ACO vinyl box channel

## Vinyl edge

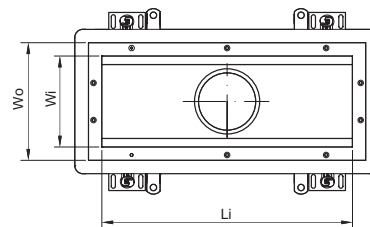
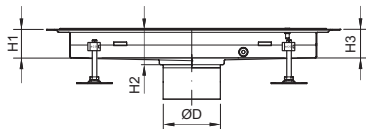

External (overall) width	Internal (grating) width	Length of channel	Height at outlet of channel	Height at end of channel
Wo [mm]	Wi [mm]	Lo	H2	H1 and H3
230	170	Variable *	50-200	50, 80, 110, 140
330	270			

Note: \* Longer channels over 6 m in length are supplied, as standard, divided into sections up to 6 m long with transport joints.  
For more information about optional protective covers see page 51.

# Gratings for ACO Marine Channel

## ACO frameless ladder grating

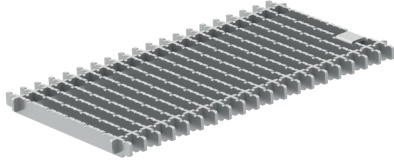

### HygieneFirst features

- Hygienic design following EN 1672, EN ISO 14159
- Fully pickled and passivated
- Electropolished surface
- Registered logo design allows for easy manipulation during cleaning
- Rounded corners
- High flow capacity
- Range of gratings suitable for load class M 125 (EN 1253)
- Slip resistant
- Low potential for slip according to BS 7976-2
- R11 according to DIN 51130

## ACO hygienic ladder grating

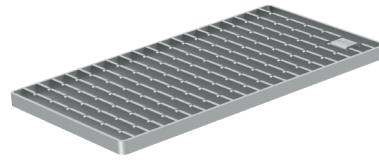

### HygieneFirst features

- ACO mesh grating with slip resistant finish
- Tested and certified according to EN 1253
- Range of gratings suitable to load class L 15 (EN 1253)
- Electropolished surface
- High flow capacity of grates
- Rounded corners
- Slip resistant
- Slip resistant low potential for slip according to BS 7976-2
- R11 according to DIN 51130

## ACO mesh grating

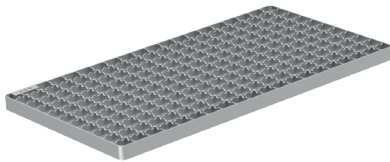

### Product features

- ACO mesh grating with slip resistant finish
- Tested and certified according to EN 1253
- Range of gratings suitable to load class L 15 (EN 1253)
- Electropolished surface
- High flow capacity of grates
- Rounded corners
- Slip resistant
- Low potential for slip according to BS 7976-2,
- R11 according to DIN 51130

## ACO hygienic slot cover

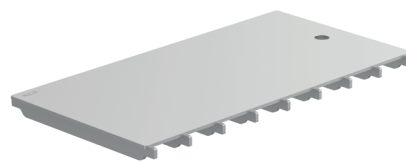

### Product features

- Hygienic design following EN 1672, EN ISO 14159
- Fully pickled and passivated
- Sandblasted surface
- Range of gratings suitable for load classes R 50, M 125 and N 250 (EN 1253)
- Rounded corners
- Slip resistant
- Low potential for slip according to BS 7976-2,
- R11 according to DIN 51130

# Accessories for ACO Marine Channel

## ACO Marine Channel with outlet pipe D 110 mm

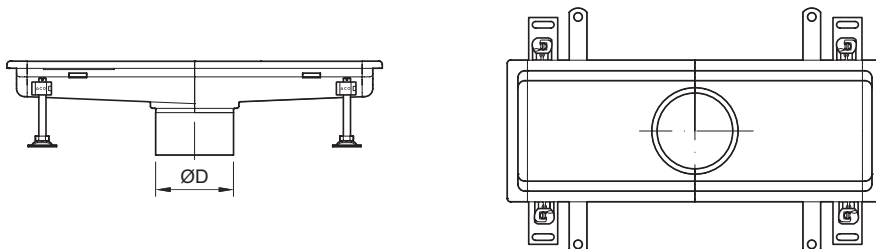

	Description	Used with	Material	Part no.
	Foul air trap ■ Stainless steel ■ Water seal 50 mm	■ ACO Marine Scupper 132 ■ ACO Marine Channel	AISI 304	97217
			AISI 316L	97267
	Sieve (for outlet 110 mm) ■ Stainless steel	■ ACO Marine Scupper 132 ■ ACO Marine Channel	AISI 304	97235
			AISI 316L	97285
	Silt basket ■ Stainless steel	■ ACO Marine Scupper 132 ■ ACO Marine Channel	AISI 304	409190
			AISI 316L	409189
	Seal for ACO scuppers - lower part 132	■ ACO scuppers - lower part 132	NBR	E63772

# ACO Marine Channel Bespoke Drainage solution

## Product information

The dimensions of the ACO customized box channel for tiles and resin floor can be easily specified in respect of project requirements.

### Product features

- Available in AISI 304 (304) or AISI 316L (316L) grades of stainless steel, pickled and passivated
- Material thickness 1.5 mm or 2 mm
- Width – up to customer request
- Length – up to customer request
- Depth – up to customer request
- Variable shape of channel – T shape, L shape, ...
- Longitudinal slopes of the channel bottom 1-5 %
- Outlet position central or variable in longitudinal axis or eccentric outlet
- Adjustable EasyFix levelling feet
- Anchors for fixing in concrete
- Protective cover available for recommended channel widths. See page 51 for more details

## Instruction

Please define channel dimensions by filling out required entry fields.

These option buttons highlight hygienic design requirements

These option buttons highlight possible conflicts in hygienic design

## Step 1 - Material

Stainless steel grade AISI 304 (AISI 304)

Stainless steel grade AISI 316L (AISI 316L)

## Step 2 - Edge profiles

part 1

Standard Edge			
Edge width (A)		Edge infill type	
15 mm	<input type="checkbox"/>	Rubber edge infill	<input type="checkbox"/>
Custom: <input type="text"/> mm	<input type="checkbox"/>	PUR edge infill	<input type="checkbox"/>
		Steel edge infill **	<input type="checkbox"/>
		No edge infill	<input type="checkbox"/>

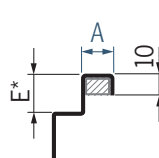

Extended Edge			
Edge width (A)		Edge infill type	
15 mm	<input type="checkbox"/>	Rubber edge infill	<input type="checkbox"/>
Custom: <input type="text"/> mm	<input type="checkbox"/>	PUR edge infill	<input type="checkbox"/>
		Steel edge infill **	<input type="checkbox"/>
		No edge infill	<input type="checkbox"/>
		Flange length (D)	
		50 mm	<input type="checkbox"/>
		Custom: <input type="text"/> mm	<input type="checkbox"/>

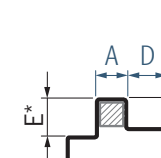

\* Sitting height for gratings (E) is defined in step 7  
 \*\* For hygienic solution, check with technical support

## Step 2 - Edge profiles

part 2

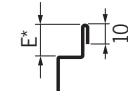
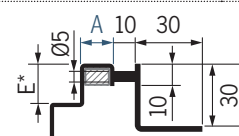
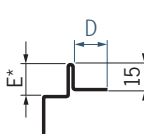
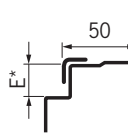
<b>L-profile edge</b>	<input type="checkbox"/>	<b>Folded edge</b>	<input type="checkbox"/>
<b>Edge width (A)</b>	<input type="checkbox"/>		
15 mm	<input type="checkbox"/>		
Custom: <input type="text"/> mm	<input type="checkbox"/>		
<b>Edge infill type</b>	<input type="checkbox"/>		
Rubber edge infill	<input type="checkbox"/>		
PUR edge infill	<input type="checkbox"/>		
Steel edge infill **	<input type="checkbox"/>		
No edge infill	<input type="checkbox"/>		
			
<b>Folded edge with flange</b>	<input type="checkbox"/>	<b>Vinyl edge</b>	<input type="checkbox"/>
	<b>Flange length (D)</b>		
	50 mm		
	Custom: <input type="text"/> mm		

\* Sitting height for gratings (E) is defined in step 7

\*\* For hygienic solution, check with technical support

## Step 3 - Channel dimensions

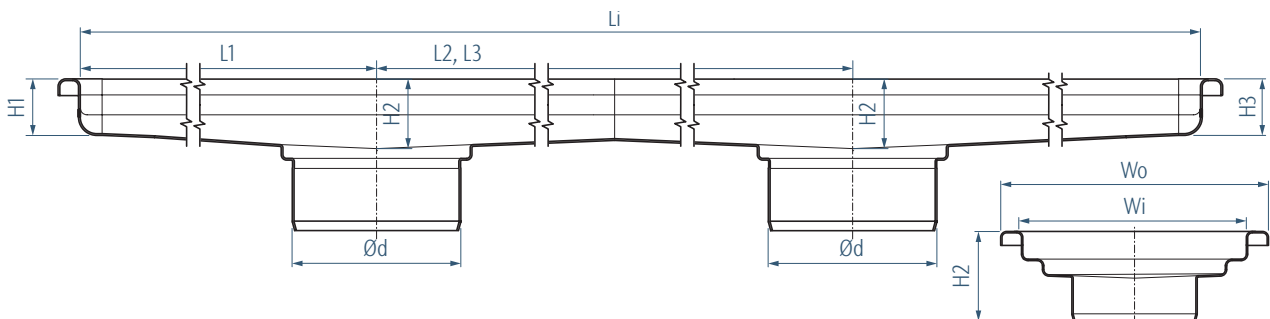

Width Overall (Wo) / Internal (Wi)	Channel height at outlet	Channel Length	Outlet diameter [Ød]
200/170 *	H2 [mm]	Li [mm]	110
300/270 *	<b>Slope</b>	<b>Number of outlets and their spacing</b>	125
400/370 *	No	L1 [mm] ****	
500/470 *	Yes - 1%	L2 [mm] ****	
600/570 *	Yes - height defined ***	L3 [mm] ****	
800/770 *	H1 [mm]	L4 [mm] ****	
Customized width **	H3 [mm]		
Wo [mm]	<input type="text"/>		
Wi [mm]	<input type="text"/>		

Note:

\* Valid for edge width 15 mm (E)

\*\* For channel with standard edge width of 15 mm subtract 30 mm from overall width as value for internal width

\*\*\* If you require values below 50 mm, please contact technical support

\*\*\*\* For higher number of outlets, please contact technical support

### Step 4 - Scupper

Without scupper (outlet pipe only)

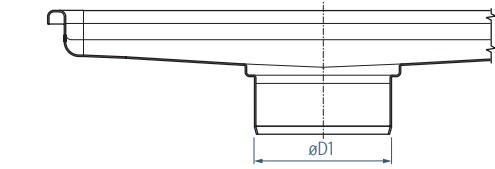

Outlet diameter [Ød]

110

125

### Step 5 - Accessories

Foul air trap

Yes

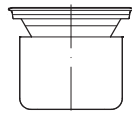

No



Sieve

Yes



No



### Step 6 - Delivery requirements

Transport connection

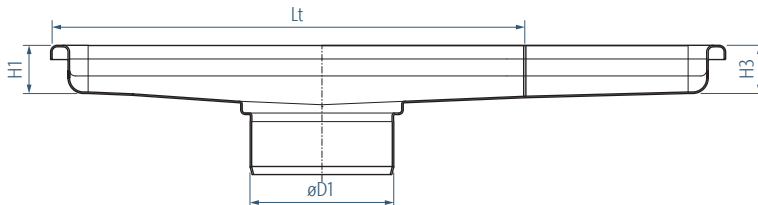

ACO EasyFix levelling feet [H]

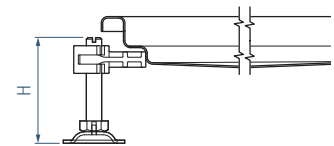

Length (Lt) [mm]	Connection type	
	Welded on site	Rubber seal
6 000 (standard)	<input type="checkbox"/>	<input type="checkbox"/>
3 000	<input type="checkbox"/>	<input type="checkbox"/>
2 000	<input type="checkbox"/>	<input type="checkbox"/>

80 (standard)	<input type="checkbox"/>
110	<input type="checkbox"/>
170	<input type="checkbox"/>
200	<input type="checkbox"/>

\* Sitting height for gratings (E) is defined in step 7

\*\* For hygienic solution, check with technical support

Step 7 - Gratings

part 1

ACO frameless ladder grating

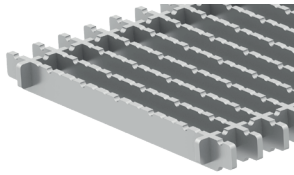

Load class

M 125 \*\*\*

Slip resistant

ACO hygienic ladder grating

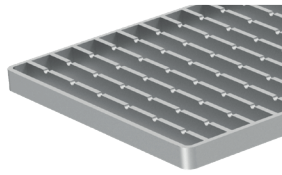

Load class

R 50 \*

M 125 \*\*

Slip resistant

N 250 \*\*\*

Plain

P 400 (custom)

ACO mesh grating

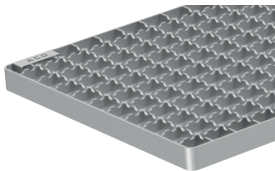

Load class

L 15 \*\*\*\*

R 50 \*\*\*

(max. Wo = 300 mm)

M 125 \*\*\*

(max. Wo = 300 mm)

Slip resistant

Plain

ACO hygienic slot cover

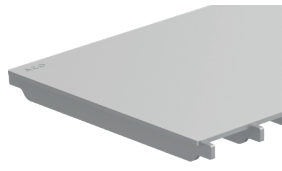

Load class

R 50 \*\*\*

(max. Wo = 300 mm)

M 125 \*\*\*

(max. Wo = 300 mm)

Slip resistant

ACO multi-slot 5 grating

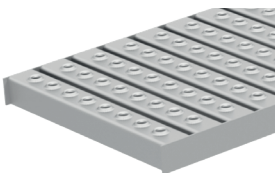

Load class

L 15 \*\*\*

R 50 \*\*\*

(max. Wo = 300 mm)

Slip resistant

ACO heelsafe grating

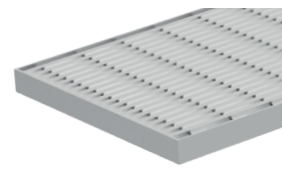

Load class

L 15 \*\*\*

(max. Wo = 300 mm)

Plain

## Step 7 - Gratings

part 2

Without grating

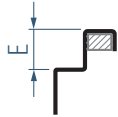

Height of gratings (E)

20 mm

25 mm

30 mm

40 mm

## Step 8 - Protective covers

With protective covers



Note:

For more information about protective covers, see page 51.

\* Sitting height for gratings (E) is defined in step 7  
 \*\* For hygienic solution, check with technical support



# ACO Design Channel

## Product information

Even atypical solutions can be easily realised using stainless steel. The broad spectrum of finishes and shapes gives complete design freedom.

Customers' individual channel designs will be managed by our expert team with tailor-made services for specific projects with full proposal information, CAD layout drawings and assembly instructions.

Contact our Sales/Technical department team and we will help you with your project.

3



# Transport & handling information

## ACO Marine Scupper

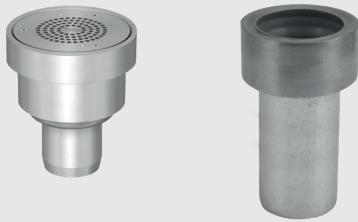

- ACO Marine Scuppers are packed on framed pallets, protected by cardboard inserts and PE foil. Individual products are packed in protective plastic net.
- Outlet pipes are equipped with protective lids.
- Gully tops and flanges are covered with protective blisters, which also protect the inside areas during installation. Individual products are packed in plastic protective net.
- Handle the scupper/ scupper parts with care. Any rough manipulation (like dragging along the ground, dumping off the truck...) can cause deformation and potentially cause product malfunctions.
- Contact with carbon steel may cause stainless steel corrosion.

## ACO Marine Channel

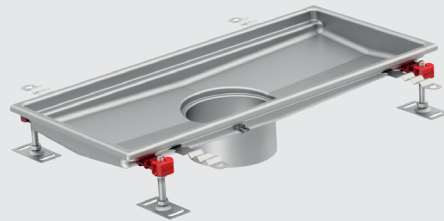

- The maximum transportable length of channel is 6 000 mm. In case of container or air transport, the recommended maximum transport length is 2 000 mm. Longer channels over 6 000 mm in length are supplied, as standard, divided into sections up to 6 000 mm long with transport joints.
- If one piece channel is required, the channel will have to be welded on site. Please contact our Sales/ Technical department.
- ACO Marine Channel is packed on framed/ non framed pallets fixed by plastic tape.
- Products are protected by wooden inserts and frames, in some cases PE foil or bubble foil is used.

## ACO Grating

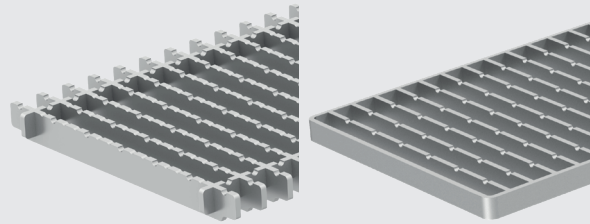
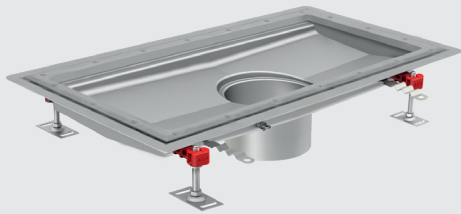

- Articles are either wrapped separately in ACO paper box or placed loose within EUR pallet space. It is strongly recommended that channels / channel parts / accessories are transported in their original packaging to avoid damage and / or loss of parts.
- Store preferably on dry and flat surface.
- Handle the channels/ channel parts/ accessories with care. Careful truck un/loading procedures are crucial. Any rough manipulation (like dragging along the ground, dumping off the truck etc...) can cause deformation and potentially cause product malfunctions.
- Contact with carbon steel may cause stainless steel corrosion.

- Standard grating length for ACO Marine Channel is 500 mm and 1 000 mm.
- ACO grating is packed on framed pallets protected by cardboard inserts and PE foil.
- Articles are either wrapped separately in ACO paper box or placed loose within EUR pallet space.
- It is strongly recommended to transport gratings in their original packaging to avoid damage. Store preferably on dry and flat surface.
- Handle the gratings with care.
- Any rough manipulation (like dragging along the ground, dumping off the truck...) can cause deformation and potentially cause product malfunctions.
- Contact with carbon steel may cause stainless steel corrosion.

# Introduction

ACO Marine has designed a wide range of multi-application, high performance stainless steel floor scuppers.

## Detergents

This broad group of chemicals is widely used in food preparation areas to remove dirt and other soil material from surfaces creating a foam and emulsions that could be easily rinsed off.

## Alkalies

Alkaline compounds are effective for dissolution of proteins and removal of fats. Example of alkalies are sodium hydroxide (caustic soda) and potassium hydroxide. These compounds are hazardous to personnel and mostly used in CIP – automatic dosing system is recommended.

## Acids

Acids, both organic and inorganic, are commonly used for removal of mineral deposits, such as hard water scale. Acids are potentially corrosive to construction materials and must be used with care.

When chemical cleaning is performed, it is necessary to use low-pressure sprays, foam or gel. Foam and gel are more viscous than sprayed agents and preferred as they are not prone to aerosol formation. Selection of the correct detergent for given application should always be done in co-operation with the detergent supplier.

## Disinfectants/sanitizers

In case of high risk areas or production areas with microbiological sensitive products, the decks and drain systems should be sprayed with disinfectants/sanitizers, which will further reduce the contamination risk. The disinfectants/sanitizers will kill remaining microorganisms, according to the required specifications.

**The plant downtime and labour associated with cleaning is major cost of any food processing operation.**

- Detergents
- Alkalies
- Acids
- Disinfectants/sanitizers

## Sources of soil

Primary source of soil is from processed food product itself. Microbiological biofilms mainly contribute to the soil build up on drainage surfaces. These films vary in their solubility depending upon such factors as heat effect, age, dryness, time, etc. It is essential that personnel involved in the cleaning process have understanding of the nature of the soil to be removed before selecting a detergent and cleaning method. The rule of thumb is that acid cleaners dissolve alkaline soils (minerals), and detergents dissolve acid soils and food wastes (proteins).

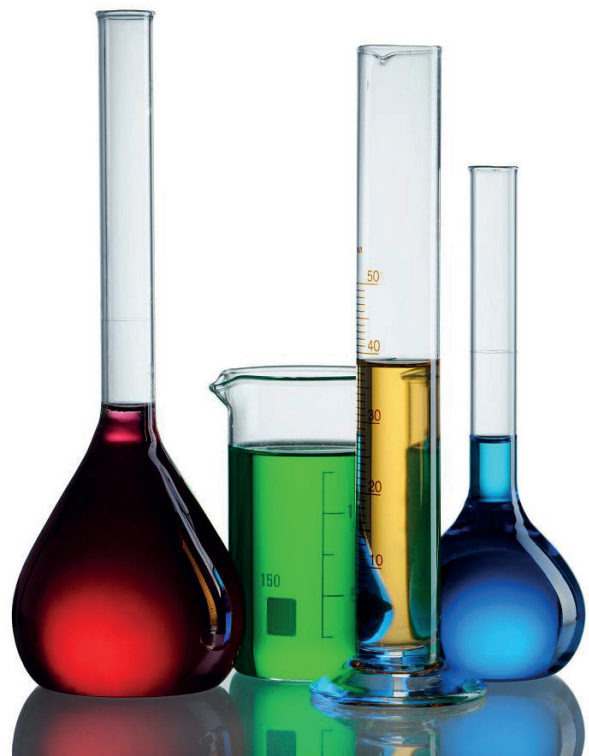

# Principles of cleaning

The principles of cleaning involve combination of thermal, kinetic and chemical energy. The cleaning processes are always combination of these factors and the time required for these to work. The key point to highlight is that all equipment – including drainage – in food processing plant should have hygienic design, which is easy to clean and disinfect. Otherwise the cleaning process is time and energy consuming and not cost effective. All surfaces of ACO stainless steel drainage are hygienically designed – no sharp corners, edges, dead spaces and crevices. ACO drainage is easily accessible for cleaning and visual inspection.

There are two different types of surface to be cleaned

## Product contact surface

All equipment that intentionally or unintentionally (e.g. due to splashing) comes into contact with final product or from which product or condensate may drain, drop or be drawn into the main product or product container.

## Non product contact surface

All other exposed surfaces, including surfaces associated with equipment, such as support structures, control panels and external surfaces. It also includes surfaces related to the manufacturing environment, such as decks, walls and drain channels.

We also differentiate between dry and wet cleaning processes

## Dry cleaning

Dry cleaning is essentially a mechanical removal of soils using sweeping, brushing, wiping and vacuuming. Environments typically to be cleaned by dry methods include areas where flour and other dry food products are used.

## Wet cleaning

Wet cleaning involves application of fluids (usually water based) to achieve the desired cleaning result. This can be applied to Open Plant Cleaning (OPC): surfaces to be cleaned have to be accessible to fluids. In addition, some components may be physically removed from production area and cleaned separately – Cleaning out of place (COP). Drainage systems require wet cleaning.

The final distinction is between manual or automatic cleaning processes

## Manual cleaning

Manual cleaning is generally considered as labour intensive and therefore often expensive. The manual tools should be hygienic – resistant to applied chemicals and suitable for a specific operation. Operators should be properly trained to be able to perform cleaning processes. ACO drainage has all the elements of hygienic design that makes cleaning of ACO drainage much easier and faster when compared to competitive products.

## Automatic cleaning

Utensils and dismantled parts of equipment are cleaned and disinfected automatically in industrial washing machines, tray or tunnel washers (automatic COP). CIP is also defined as automatic cleaning system.

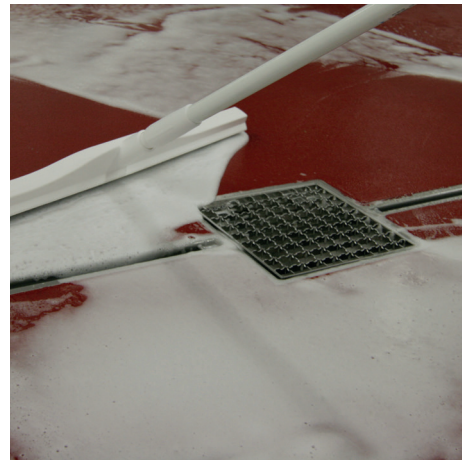

The effectiveness of drainage cleaning depends on number of factors:

- Soil type and properties
- Material, design and surfaces
- Water quality
- Cleaning chemicals
- Cleaning procedure
- Cleaning parameters; like temperature, time, flow velocity and concentration of chemicals

## Cleaning in Place (CIP)

Finding the right Cleaning in Place (CIP) solution for your plant is essential for the ultimate success of your manufacturing processes, quality, safety, increased production time, less downtime for cleaning and environmental efficiency can only be achieved with a CIP system that responds perfectly to your needs. An optimised CIP plant will give you the required results to enhance your production processes and ensure maximum hygiene and product safety at your deck.

# Cleaning chemicals

ACO Marine has designed a wide range of multi-application, high performance stainless steel floor scuppers.

- Detergents
- Alkalies
- Acids
- Disinfectants/sanitizers

## Detergents

This broad group of chemicals is widely used in food preparation areas to remove dirt and other soil material from surfaces creating a foam and emulsions that could be easily rinsed off.

## Alkalies

Alkaline compounds are effective for dissolution of proteins and removal of fats. Example of alkalies are sodium hydroxide (caustic soda) and potassium hydroxide. These compounds are hazardous to personnel and mostly used in CIP – automatic dosing system is recommended.

## Acids

Acids, both organic and inorganic, are commonly used for removal of mineral deposits, such as hard water scale. Acids are potentially corrosive to construction materials and must be used with care.

When chemical cleaning is performed, it is necessary to use low-pressure sprays, foam or gel. Foam and gel are more viscous than sprayed agents and preferred as they are not prone to aerosol formation. Selection of the correct detergent for given application should always be done in co-operation with the detergent supplier.

## Disinfectants/sanitizers

In case of high risk areas or production areas with microbiological sensitive products, the decks and drain systems should be sprayed with disinfectants/sanitizers, which will further reduce the contamination risk. The disinfectants/sanitizers will kill remaining microorganisms, according to the required specifications.

**The plant downtime and labour associated with cleaning is major cost of any food processing operation.**

## Sources of soil

Primary source of soil is from processed food product itself. Microbiological biofilms mainly contribute to the soil build up on drainage surfaces. These films vary in their solubility depending upon such factors as heat effect, age, dryness, time, etc. It is essential that personnel involved in the cleaning process have understanding of the nature of the soil to be removed before selecting a detergent and cleaning method. The rule of thumb is that acid cleaners dissolve alkaline soils (minerals), and detergents dissolve acid soils and food wastes (proteins).

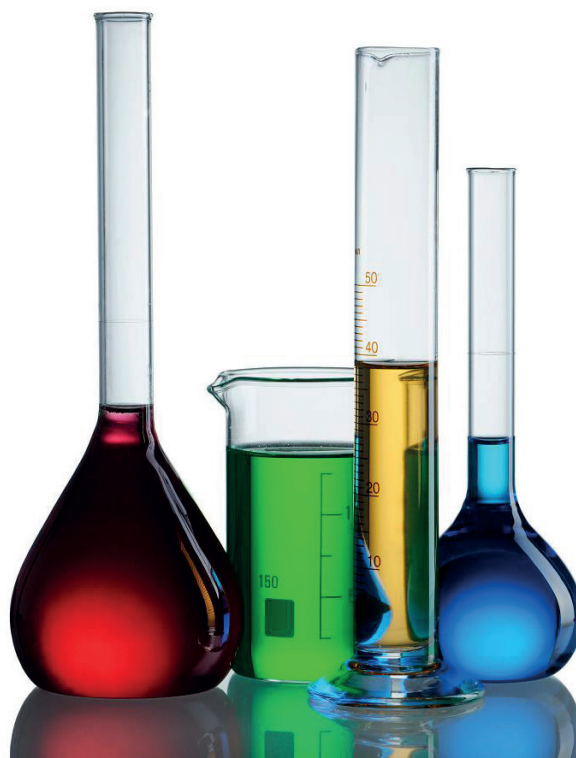

# Manual cleaning of drainage

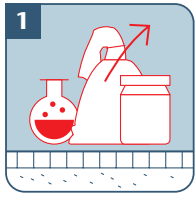

1 Remove all present grocery, raw materials, wrapping materials and tools.

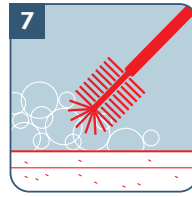

7 Wash all surfaces with designated detergent and designated hand brush.

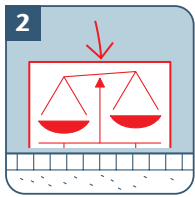

2 Cover all equipment that could be contaminated.

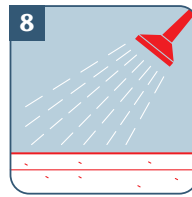

8 Rinse all surfaces with clean water.

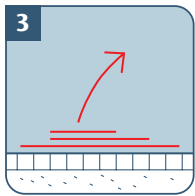

3 Remove excess dirt from floor and gratings, and place into designated container.

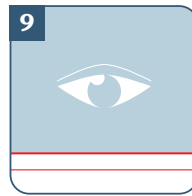

9 Visually check surface cleanliness - repeat cleaning process if necessary.

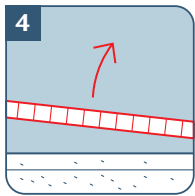

4 Remove gratings.

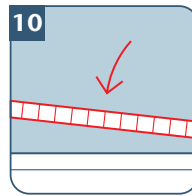

10 Place silt basket and grating to its original position.

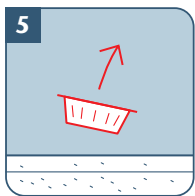

5 Remove and empty silt basket and foul air trap.

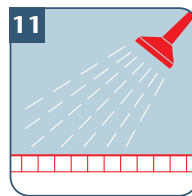

11 Rinse the entire equipment with clean water.

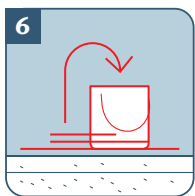

6 Place collected waste and dirt into designated container. Rinse grating, silt basket and foul air trap with clean water. Then place foul air trap into its original position.

5

# Chemical cleaning of drainage

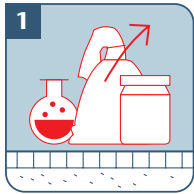

1 Remove all present grocery, raw materials, wrapping materials and tools.

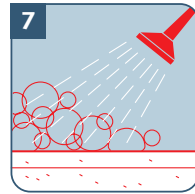

7 Apply foam to all surfaces.

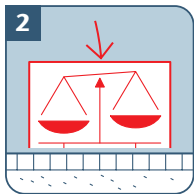

2 Cover all equipment that could be contaminated.



8 Leave foam for 15 minutes.

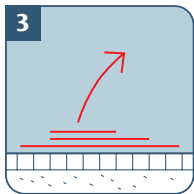

3 Remove excess dirt from floor and gratings, and place into designated container.

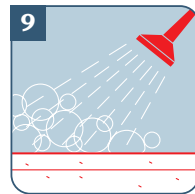

9 Rinse off foam with clean water.

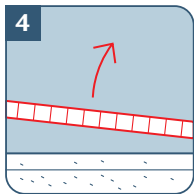

4 Remove gratings.

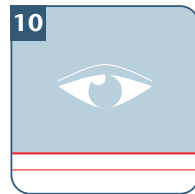

10 Visually check surface cleanliness - repeat cleaning process if necessary.

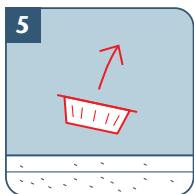

5 Remove and empty silt basket and foul air trap.

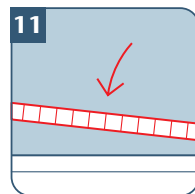

11 Place silt basket and grating to its original position.

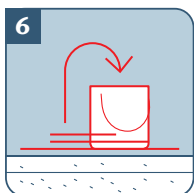

6 Place collected waste and dirt into designated container. Rinse grating, silt basket and foul air trap with clean water. Then place foul air trap into its original position.

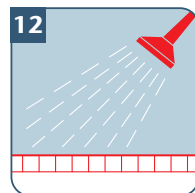

12 Rinse the entire equipment with clean water.



# Overview with recommended cleaning procedures for drainage

These instructions are for guidance only.  
**Always follow manufacturer's instructions.**

All procedures have to be verified and adjusted to the application specifics.

Frequency	Procedure	Physical agents	Chemical agents	Examples of chemical cleaning agents suitable for ACO stainless steel drainage
Daily	Removal of organic deposits (fats, proteins, saccharides and polysaccharides)	<ul style="list-style-type: none"> <li>■ Steam</li> <li>■ Medium pressure water to max 25 bar</li> <li>■ Mechanical / kinetic energy (brushes, CIP medium velocity)</li> </ul>	<ul style="list-style-type: none"> <li>■ Caustics (sodium hydroxide, potassium hydroxide)</li> <li>■ Detergents / surfactants</li> </ul>	Standard chemical agents used for floor cleaning should be sufficient (should be validated) Oxofoam, Endorochlor
Weekly	Removal of inorganic deposits that could promote very resistant biofilms	Mechanical abrasive methods – polishing	<ul style="list-style-type: none"> <li>■ Nitric acid for stainless steel passivation where chlorine attack could be expected</li> <li>■ Inorganic acids (phosphoric acid)</li> <li>■ Weak organic acids</li> </ul>	<ul style="list-style-type: none"> <li>■ Acifoam</li> <li>■ Acigel</li> <li>■ Super Dilac</li> </ul>
Note	Removal of rinse water residues	Removal of excess water with a squeegee	Alcohols (isopropylalcohol, ethanol)	Chlorine tablets are often added to the water in foul trap in microbial sensitive production area's

Any cleaning procedures, including those recommended by equipment suppliers, must be properly validated at the equipment, where it will be applied and on the soil that could be expected even after certain time of usage.

**Always follow manufacturer's instructions to avoid damage to the equipment.**

# ACO hygienic box channel

## ACO hygienic box channel - standard edge connected to tiled floor

- 1 Tiled floor
- 2 Floor screed
- 3 Steel deck
- 4 ACO Marine Scupper - Lower part

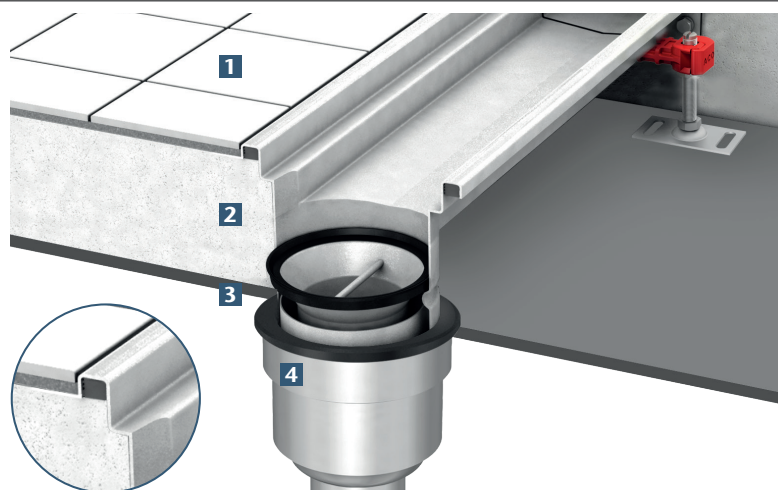

## ACO hygienic box channel - standard edge connected to resin floor

- 1 Epoxy/resin floor
- 2 Floor screed
- 3 Steel deck
- 4 ACO Marine Scupper - Lower part

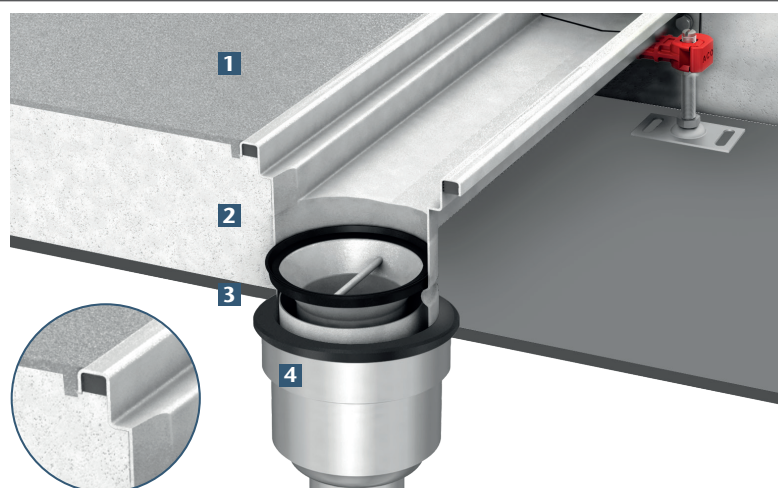

## ACO hygienic box channel - I-profile edge connected to resin floor

- 1 Epoxy/resin floor
- 2 Insulation
- 3 Floor screed
- 4 Steel deck
- 5 ACO Marine Scupper - Lower part

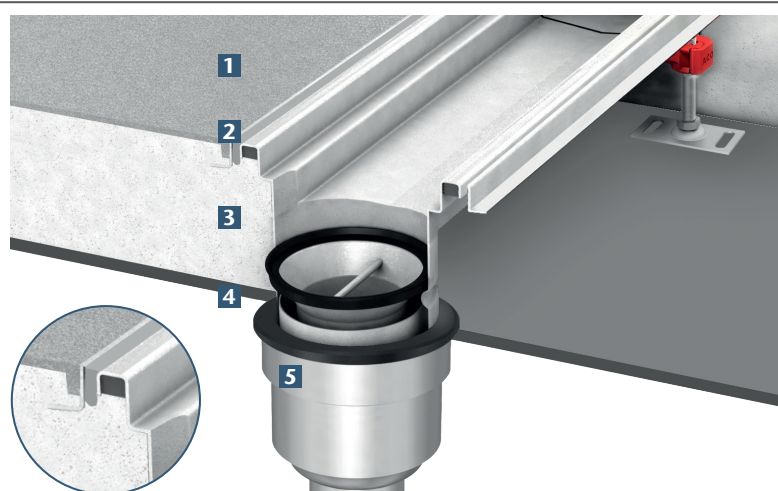

# ACO vinyl box channel

## ACO vinyl box channel connection to vinyl floor

- 1 Vinyl floor
- 2 Floor screed
- 3 Steel deck
- 4 ACO Marine Scupper - Lower part

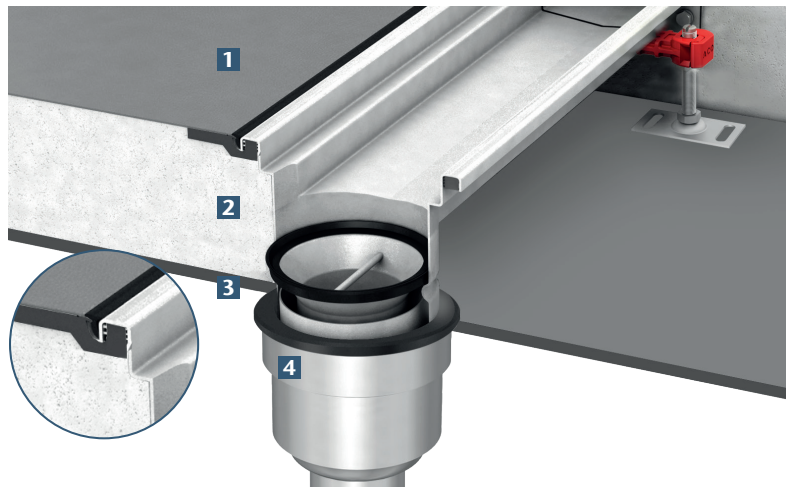

# ACO protective covers

## Description

### Features and benefits

- Protection from installation material debris
- Eliminates cleaning of drainage after installation
- Prevents injuries on worksite
- Certified according to EN 12811-1 for scaffolding load class 3
- Eco friendly and easily disposable

### ACO protective covers made from OSB are available for:

- All ACO Marine Scuppers and ACO Marine Channels, standard, semi-standard and customized
- ACO vinyl deck channels, standard, semi-standard and bespoke solutions

### Order information:

- For standard articles, add \_C at the end of product article number (example: 111111\_C)
- For semi-standard and bespoke articles, specify this option in the order process



Load area	Maximum load capacity	Maximum pressure
200 x 200 mm	max. 100 kg	max. 2.5 N/cm <sup>2</sup>
500 x 500 mm	max. 150 kg	max. 0.6 N/cm <sup>2</sup>
1000 x 1000 mm	max. 200 kg	max. 0.2 N/cm <sup>2</sup>

Classification according to EN 12811-1

# Resistance of Material

- 1 = Very good service to operating limit of material  
2 = Moderate service  
3 = Limited or variable service  
4 = Unsatisfactory

	AISI 316L Stainless	AISI 304 Stainless	EPDM	NBR	FPM
Acetone	1	1	1	4	4
Acetic acid (diluted) 30%	1	1	1	2	2
Acetic acid 100%	1	1	1	3	3
Acetic acid anhydride	1	1	2	3	4
Aluminium chloride	4	4	1	1	1
Aluminium sulfate	1	4	1	1	1
Ammonium carbonate	1	1	1	4	2
Ammonium chloride	2	3	1	1	1
Ammonium hydroxide	1	1	1	4	2
Amyl chloride	1	1	4	4	1
Anilin	1	1	2	4	3
Anilin hydrochloride	4	4	2	2	2
Barium chloride	2	2	1	1	1
Barium hydroxide	1	1	1	1	1
Benzaldehyde	1	1	1	4	4
Benzene	1	1	4	4	1
Benzoic acid	1	1	4	4	1
Borax	1	1	1	2	1
Boric acid	1	1	1	1	1
Bromine	4	4	4	4	1
Bromine chloride acid	4	4	1	2	1
Bromine hydrogen acid	4	4	1	4	1
Bromoethylene	1	1			
Butanol	1	1	4	1	1
Butyl acetat	1	1	2	2	4
Butyric acid	1	1	2	4	4
Calcium bisulfate el sulfite	1	1	4	1	1
Calcium chloride	2	2	1	1	1
Calcium hydroxide	1	1	1	1	1
Calcium hypoklorite	2	3	1	3	1
Carbon disulfide	1	1	4	4	1
Carbon tetrachloride	1	1	4	3	1
Chloracetic acid (mono)	4	4	2	4	4
Chloride	4	4			
Chloril acid	4	4	1	4	
Chlorine (dry)	1	1	1	2	1
Chlorobenzene	1	1	4	4	1
Chloroform	2	2	4	4	1
Chlorosulfonic acid	2	3	4	4	3
Copper chloride	2	2	1	1	1
Copper nitrate	1	1	1	1	1
Copper sulfate	1	1	1	1	1
Ether	1	1	3	4	3
Ethyl chloride	1	1	1	1	1
Foul Air Trap ty acid	1	1	4	2	1
Flourine (dry)	1	1			
Flourine hydrogen acid	4	4	2	4	1
Formaldehyde	1	1	1	2	1
Formic acid	1	1	1	2	3
Furfural	1	1	2	4	4
Gallic acid	1	1	2	2	1
Hydrochloric acid	4	4	1	4	1
Hydrogen peroxide	1	1	3	4	2
Iodine (wet)	4	4	2	2	1
Lead acetate	1	1	1	2	4

Note:  
Concentration levels and length of exposure have a direct influence on the resistance of stainless steel to certain chemicals.

Each application should therefore be carefully reviewed to determine the suitability of stainless steel.

- 1 = Very good service to operating limit of material  
2 = Moderate service  
3 = Limited or variable service  
4 = Unsatisfactory

	AISI 316L Stainless	AISI 304 Stainless	EPDM	NBR	FPM
Magnesium chloride	2	2	1	1	1
Magnesium sulfate	1	1	1	1	1
Mercury	1	1	1	1	1
Methanol	1	1	1	1	3
Methyl chloride	1	1	3	4	1
Methylene chloride	2	2	4	4	2
Natphalene	1	1	4	4	1
Nickel chloride	2	2	1	1	1
Nickel sulfate	1	1	1	1	1
Nitric acid	3	3	3	4	1
Oxalic acid	3	3	1	2	1
Perchloric acid	4	4	2	4	1
Phosphor acid	1	1	2	4	1
Picric acid	1	1	2	2	1
Potassium bromide	1	1	1	1	1
Potassium carbonate	1	1	1	2	1
Potassium chlorate	1	1	1	1	1
Potassium cyanide	1	1	1	1	1
Potassium hydroxide	1	1	1	2	2
Potassium nitrate	1	1	1	1	1
Potassium permanganate	1	1	1	3	1
Potassium sulfate	1	1	1	1	1
Potassium sulfide	1	1	1	1	1
Potassiumchloride	2	2	1	1	1
Propylene dichloride	1	1	4	4	1
Sal ammoniac	2	3	1	1	1
Silver nitrate	1	1	1	2	1
Soda (ash)	1	1	1	1	1
Sodium acetate	1	1	1	2	4
Sodium bicarbonate	1	1	1	1	1
Sodium bisulfate	1	3	1	2	1
Sodium bisulfite	1	1	1	1	1
Sodium bromide	2	2	1	3	1
Sodium chlorate	1	1	1	2	1
Sodium chloride	4	4	1	1	1
Sodium cyanide	1	1	1	1	1
Sodium fluoride	1	1	1	1	1
Sodium hydroxide	1	1	1	2	2
Sodium hypoklorite	4	4	2	2	1
Sodium nitrate	1	1	1	2	2
Sodium sulfate	1	1	1	1	1
Sodium sulfide	1	1	1	1	1
Sodium sulfite	1	1	1	1	1
Stannicous chloride	2	3	2	1	1
Sulfur	1	1	1	4	1
Sulfur chloride	1	1	4	3	1
Sulfur dioxide	1	2	1	4	1
Sulfuric acid	4	4	2	4	1
Sulfurous acid	1	3	2	2	1
Tionyl chloride	1	1	4	4	1
Toluene (toluol)	1	1	4	4	1
Trichloroethylene	1	1	4	3	1
Turpentine	1	1	4	1	1
Xylene (xylol)	1	1	4	4	2
Zinc sulfate	1	1	1	1	1

Assumptions:  
Data presented are used as a guide only, for detailed information please contact our Sales/Technical department.

# Sealing material information

## EPDM

### (ethylene propylene diene monomer)

Black sealing rubber ring, which is suitable for most applications where there are no oil or petrol residues in the waste water.

## NBR

### (acryl nitrile-butadiene rubber)

Black sealing rubber ring which is suitable for waste water applications where there are petrol or oil residues. NBR is not resistant to solvents and high temperatures.

## FPM

### (fluoroelastomer) – Viton®

Green sealing rubber ring which is suitable for special applications where oil, solvents and strong acids are present in waste water; and for applications with higher temperatures. Viton® seal has limited resistance to chemicals like acetone, methyl alcohol.

Rubber type	Sealing materials		
	EPDM	NBR	FPM (Viton®)
Colour	black	black	green
Temperature range	-50 / +130 / +150 °C	-30 / +80 / +100 °C	-20 / +200 / +300 °C
<b>Resistance</b>			
Water	excellent	good	good
<b>Chemicals</b>			
Acids	good	fair	excellent
Bases	good	fair	excellent
Benzene/Petrol	unsatisfied	excellent	excellent
<b>Oils</b>			
ASTM Oil No. 1	unsatisfied	excellent	excellent
ASTM Oil No. 3	unsatisfied	excellent	excellent
Ozone & weather stresses	good	limited	good

**Note:**

To be sure of suitability for special applications please consult exact seal material features within ACO installation guide.



8

Free deck  
drainage

**COLLECT:**  
Collect and remove



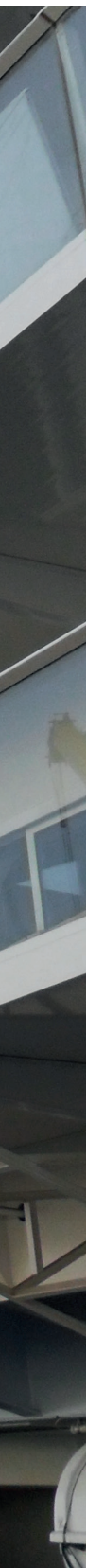

<b>chapter</b>	<b>section</b>	<b>heading</b>	
		Introduction - ACO Free Deck Scuppers	56
		System overview - ACO Free Deck Scuppers	57
		ACO scuppers with welded cross	57
<b>Free deck drainage</b>	ACO Marine Free Deck Scuppers	ACO scuppers with flange - hot dip galvanized and internally coated (resin floor)	58
		ACO scuppers with flange - hot dip galvanized (tiled floor)	58
		ACO scuppers - hot dip stainless steel	59



# Introduction - ACO Free Deck Scuppers

ACO Marine has designed a wide range of multi-application, high performance galvanized steel deck scuppers.

The ACO Marine GM-X Steel range of scuppers is designed to provide quick, simple and economic trapped drainage solutions for decks, etc.

All floor finishes, including all resin screeds, ceramic tiles, flexible vinyl sheet in solid and suspended flooring applications are catered for.

Optional side inlet facilities are provided to fit the hand basin and the condensation waste pipes.

## Typical Application

- Drainage for Free decks

## ACO Product Benefits

- Ultra-compact design ideal for suspended deck applications
- Quick, easy installation in screed, tiled or flexible vinyl deck material finishes
- Choice of Ø 159, 133, 102, 89, 73 and 53 mm vertical spigot outlets
- Attractive, neat appearance
- Telescopic height variant providing full 360° rotation and +/- 7.5° pitch & roll adjustment
- End stops provided preventing accidental dismantling on telescopic variants
- Supplied boxed complete with fitting instructions - no loose parts

## Galvanized steel

Free deck galvanized steel scuppers are manufactured from welded, one-time cold-drawn precision steel sheet in accordance with DIN 2394.

Tensile strength: Rm 310-410 N/mm<sup>2</sup>

Elongation at break: A5 min. 28%

As a material, the practical properties of steel include:

- Virtually unbreakable
- Dimensionally stable
- Heat and frost proof
- Favourable acoustic behaviour
- Non-combustible

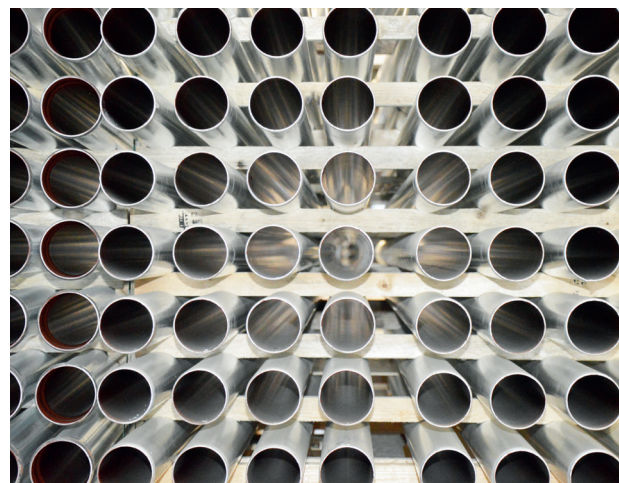



# System overview

## ACO Free Deck Scuppers

### ACO Galvanized Steel Scuppers



Scupper body

8

## ACO scuppers with welded cross

### Order information

Drawing	D1 [mm]	D2 [mm]	H1 [mm]	H2 [mm]	Weight [kg]	Material	Part no.
	53	76	160	50	0.93	Galvanised Steel	E97 082 002
	75	95	160	50	1.47		E97 083 002
	89	127	160	50	1.88		E97 084 002
	102	133	160	50	1.99		E97 085 002
	133	168	160	50	2.71		E97 086 003
	159	197	209	50	5.10		E97 087 003

# ACO scupper with flange hot dip galvanized and internally coated (resin floor)

## Order information

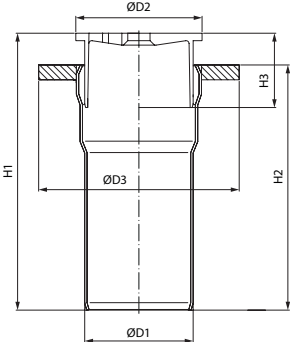
Drawing	D1 [mm]	D2 [mm]	D3 [mm]	H1 [mm]	H2 [mm]	H3 [mm]	Weight [kg]	Material	Part no.
	73	82	135	185 - 205	165	50	1.65	Galvanised Steel	405492

# ACO scupper with flange hot dip galvanized (tiled floor)

## Order information

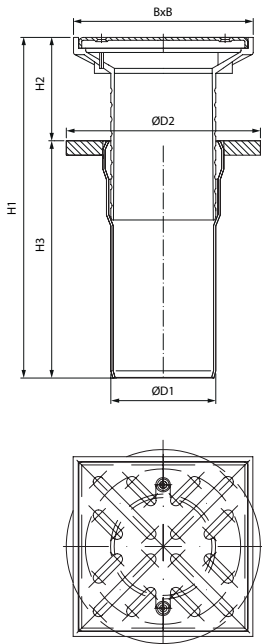
Drawing	D1 [mm]	D2 [mm]	B x B [mm]	H1 [mm]	H2 [mm]	H3 [mm]	Weight [kg]	Material	Part no.
	75	135	125	236 - 264	70 - 98	165		Galvanised Steel	405493

# ACO scupper - hot dip stainless steel

## Order information

Drawing	D1 [mm]	D2 [mm]	D3 [mm]	D4 [mm]	H1 [mm]	H2 [mm]	Material	Part no.
	50	50	60	89 x 8.8	155	100	Stainless Steel	Z265065
	75	75	85	108 x 8.8	160	100		Z265066
	110	110	120	152 x 8.8	160	100		Z265067
	125	125	135	168 x 8.8	180	100		Z265068

8

Each product from ACO Marine  
supports the ACO system chain



ACO Marine s.r.o.

Nadrazni 72  
CZ - 150 00 Prague 5  
Czech Republic  
Tel.: +420 257 217 990

[acomarine@acomarine.com](mailto:acomarine@acomarine.com)  
[www.acomarine.com](http://www.acomarine.com)